



Installation and Maintenance Manual
CTC Expansion EnergyFlex



Translation of the original instructions.

Keep for future use.

Read carefully before use.

162 505 78-3 CR00680 2024-03-21



MADE IN SWEDEN

Table of contents

1. Technical data	5	4.6 Connection table for Expansion Card A3.....	28
Delivery includes:.....	5	5. Detailed menu descriptions	29
Accessories.....	5	5.1 Navigate on the touchscreen.....	29
2. EnergyFlex	6	5.2 Start menu.....	29
2.1 System options.....	7	Installer.....	30
2.1.1 EnergyFlex schematic diagrams.....	8	5.3 Define.....	30
2.1.2 EcoSol - Example CTC EcoHeat and CTC EcoZenith i255 H/L.....	9	5.3.1 Def. Diff thermostat function.....	30
3. System structure	10	5.3.2 Def. Pool.....	31
3.1 Solar Panel.....	10	5.3.3 Def. Solar Panel.....	31
3.1.1 Solar system 1.....	10	5.3.4 Def. DHW/DHW circulation.....	31
3.1.2 Solar system 2.....	10	5.4 Settings.....	32
3.1.3 Solar system 2b with solar coil.....	12	5.4.1 Settings Diff thermostat function.....	32
3.1.4 Solar system 3.....	13	5.4.2 Settings Solar Panels.....	33
3.1.5 System option: bedrock heating.....	14	5.4.3 Settings DHW circulation.....	36
3.2 Pool.....	15	5.4.4 Settings Pool.....	37
3.3 Diff thermostat function.....	15	5.5 Operation data.....	39
3.4 DHW circulation (DHW circ).....	15	5.5.1 Solar Panels.....	39
3.5 Parts list.....	16	5.5.2 Operation data, Diff thermostat function.....	40
4. Installation	17	5.5.3 Operation data, Pool.....	41
4.1 Safety switch.....	18	5.5.4 Operation data DHW circulation.....	41
4.2 Communication between extension card and main product.....	18	5.6 Service.....	42
4.3 High voltage.....	18	5.6.1 Function test.....	42
4.3.1 Pump, solar panel (G30, PWM) Wilo Stratos Para.....	18	5.7 Alarm texts and Troubleshooting/Appropriate measures.....	44
4.3.2 Circulation pump, solar collector (G30) Grundfos UPM3 Solar.....	19		
4.3.3 Pump bore hole charging (G31, on/off).....	21		
4.3.4 Pump, intermediate heat exchanger solar panels (G32) PWM.....	21		
4.3.5 Pump tank transfer (G46, on/off).....	21		
4.3.6 Pool.....	22		
4.3.7 Valve 2 tanks (Y30).....	22		
4.3.8 Valve bedrock (Y31).....	22		
4.4 Sensor installation.....	23		
4.4.1 Sensor connection (extra low voltage protection).....	24		
4.4.2 Factory-fitted sensors.....	25		
4.4.3 Resistance level of the temperature sensors.....	26		
4.5 Wiring diagram.....	27		

Software update



software.ctc.se

EN

For more information on updated functions and downloading the latest software, see the website "software.ctc.se".

Installation and Maintenance Manual

CTC Expansion EnergyFlex

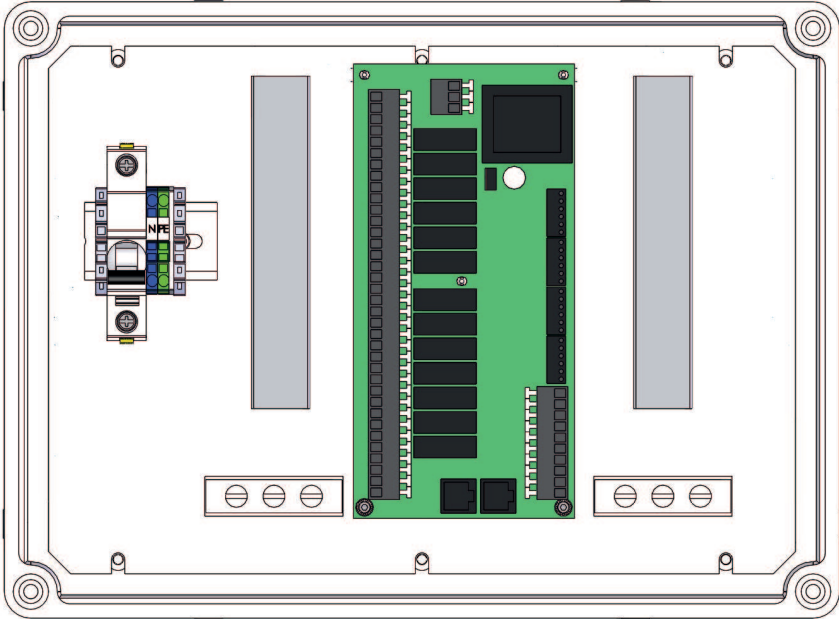
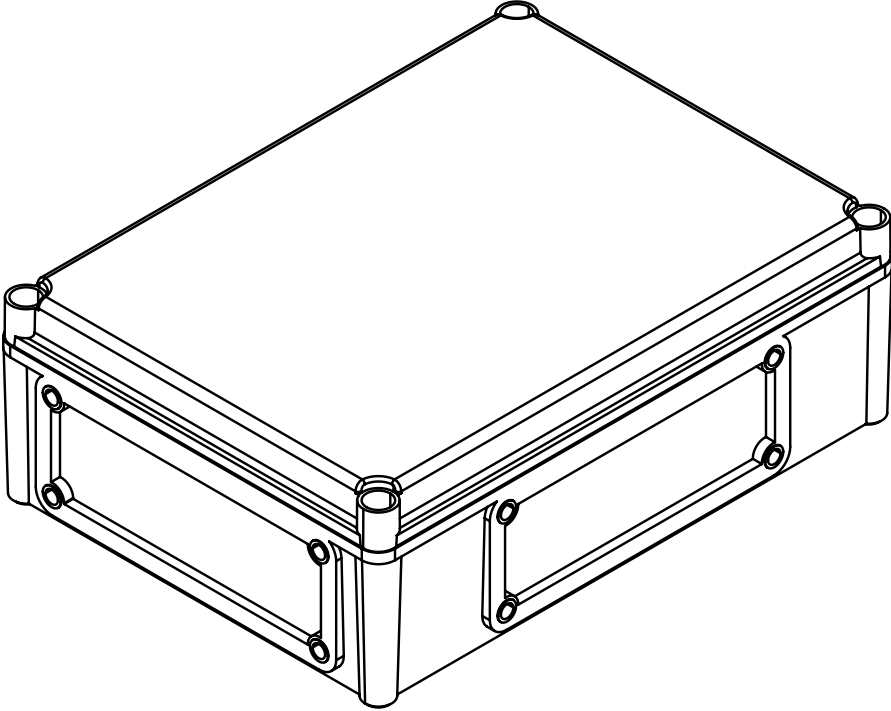

Congratulations on your new product



CTC Expansion EnergyFlex

With CTC Expansion EnergyFlex, you can control your solar collectors or heat your pool, for example, directly from the menus of your CTC product, providing an integrated control system.

Positioning

Place the control unit indoors on a wall next to the product. The control unit must be positioned so that normal service procedures can be carried out. There should be at least 0.5 m of free space in front of the unit. Ensure that the screws fixing the cover to the unit are easily accessible.

Safety instructions

Installation must be carried out by a qualified electrician.

This device can be used by children from the age of three years and above and by people with reduced physical, sensory or mental ability or lack of experience or knowledge if they have been taught, either with

supervision or with the instructions provided, how to use the device safely and understand the risks involved. Children should not play with the device. Cleaning and maintenance should not be carried out by children without supervision.

System requirements

Program version for the display card must be 2014-12-19 or later.

CTC Expansion EnergyFlex complements the following products with several additional functions (refer to the "System Design" chapter).

CTC EcoHeat 400

CTC EcoZenith i250/i255

CTC GSi

CTC GS

CTC EcoZenith i350/i360

CTC EcoVent i350F/i360F

Information for the property owner to note

Complete the fields below. This information is useful if any servicing work is required

Product :	Manufacturing number:
Installation company	Tel. no.
Date	Name
Electrical installation company	Tel. no.
Date	Name

Enertech AB provides the information with reservation for any typing errors and subject to modification.

1. Technical data

Supply	230V 1N~.
Max fuse size	10 A
Total max. load CTC Expansion EnergyFlex	10 A
Max load relay output	4 A
Electrical data 3-way valve	230V 1N~.
Sensor (extra-low voltage protection), NTC22k, °C/ohm	0/66k, 10/41.8k, 15/33.5k, 20/27.1k, 25/22k, 30/18k, 35/14.8k, 40/12.2k, 50/8.4k, 60/6.0k, 70/4.3k, 80/3.1k, 90/2.3k, 100/1.7k
Solar panel sensor*, type PT1000, °C/ohm	-10/960, 0/1000, 10/1039, 20/1077, 30/1116, 40/1155, 50/1194, 60/1232, 70/1271, 80/1309, 90/1347, 100/1385, 120/1461, 140/1535
Measurements (w x h x d)	379 x 279 x 131 mm

Delivery includes:

- A 1 x electrical connection box with extension card
- B 2 x NTC 22k sensors
- C 2 x RJ-45 communication cables
- D 1 x Installation and Maintenance Manual
- E 1 x flange grommet including cable penetrations



Accessories

The most important accessories for supplementing solar energy and EnergyFlex are shown below.

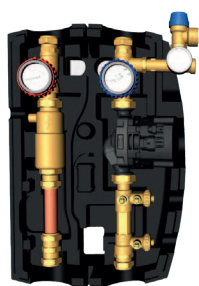

CTC Flowbox



Installation kit GSi EHS



EnergyFlex kit 400

Pipe kit, pre-bent pipes, connections and insulation for "solar output".

2. EnergyFlex

EnergyFlex works with heat pumps/indoor modules CTC EcoHeat 400, CTC EcoZenith i250/i255, CTC GSi, CTC GS, CTC EcoZenith i350/i360 and CTC EcoVent i350F/i360F.

EnergyFlex is a collective term that describes CTC's unique options for maximum flexibility and simple interconnection between different heat sources. The most common combination is a heat pump and electric boiler.

The CTC EcoZenith i250/i255, CTC EcoZenith i350/i360 and EcoVent i350F/i360F indoor modules are equipped for connection with:

- CTC EcoPart Heat Pump (ground source heat pump)
- CTC EcoAir Heat Pump (air/water heat pump)

All EnergyFlex heat pumps/indoor modules have built-in functionality so you can easily supplement with:

- Solar Energy
- Additional tanks
- Water-jacketed stove
- Wood, electric, pellet and gas boilers
- Pool

- EnergyFlex Heat Pumps
 - CTC EcoHeat 400
 - CTC GS
 - CTC GSi

- EnergyFlex Indoor Modules
 - CTC EcoZenith i250/i255
 - CTC EcoZenith i350/i360
 - CTC EcoVent i350F/i360F

(CTC EcoZenith i550/i555 comes with a factory-fitted extension card)

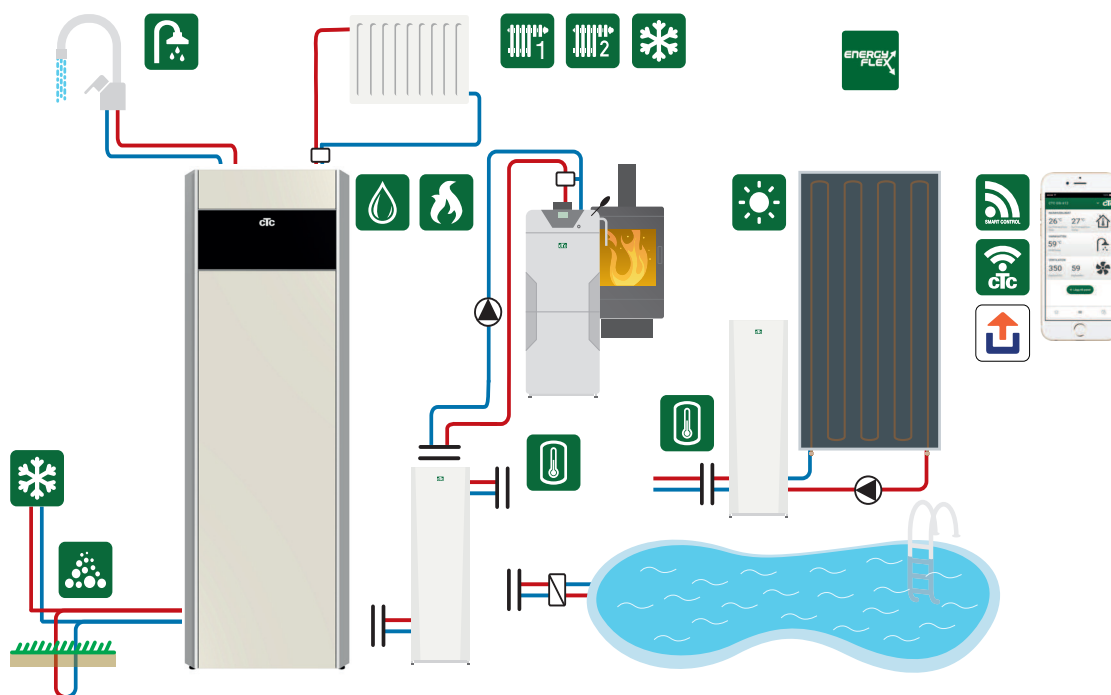

- ! Connecting external systems can seriously affect the operation and performance of the indoor module and can therefore produce undesirable effects if the system is not installed correctly.
- If you are unsure how to make the connection, contact CTC for suggestions on how to install the system.

The picture shows the possible connections. The installation engineer fits expansion tank, safety valves, bleeders, etc. and sizes the system.

2.1 System options

The flexibility in the heat pump/indoor module is optimised because the products provide functionality for up to 5 basic systems:

- **Solar system 1**
Charging from solar panel only to H-tank (CTC EcoHeat 400/CTC EcoZenith i255) or EHS-tank.
- **Solar system 2**
Charging from solar panel to buffer tank CTC EcoTank + CTC EcoHeat400/CTC EcoZenith i255.
- **Solar system 3**
Charging from solar panel either to X-volume or to CTC EcoHeat 400/CTC EcoZenith i255 or EHS-tank.

The solar energy systems also enable recharging of bedrock or collect energy for an extra tank, with or without a solar coil.

- **Diff thermostat function**
The diff thermostat function is used to transfer heat from, for example, a buffer tank or existing wood boiler to an H-tank or EHS-tank. The diff thermostat function can be connected to an existing PCB in the heat pump/indoor module, while "Solar systems 1, 2, 3" and the Pool system require the product to be supplemented with the CTC Solar Control/Extension Card accessory.
- **Pool**
The pool is connected to the heating circuit via a 3-way valve. A heat exchanger should be fitted to separate the liquids.

Important for wood-fired heating

The integrated "Diff thermostat function" control initiates the charge from, e.g., the existing wood-fired system or fireplace when the temperature is higher than it is in the main tank.

Bear in mind that it can also be a good idea to install an automatic charger that can protect the wood-fired system from condensation, etc.

If the wood-fired system needs more water than the 223 litres contained in the main product (CTC EcoHeat 400 or CTC EcoZenith i255), the system needs to be supplemented with an accumulator tank.

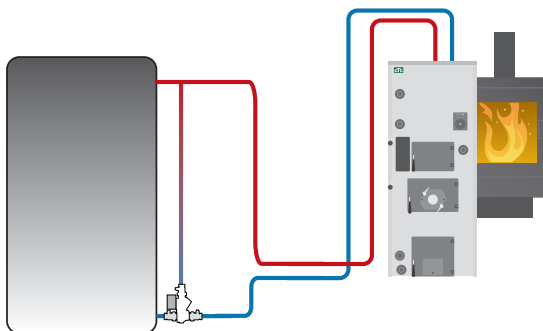

Example of wood-fired system with group of chargers.

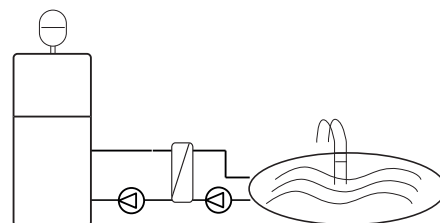

Energyflex can also be used to draw energy, e.g. to heat a swimming pool.

2.1.1 EnergyFlex schematic diagrams

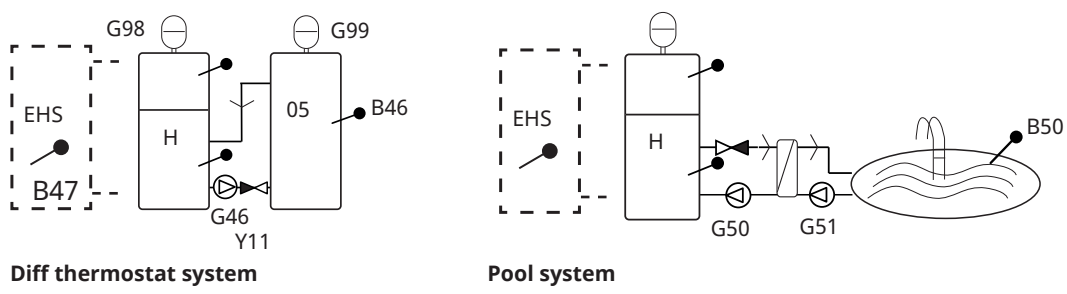
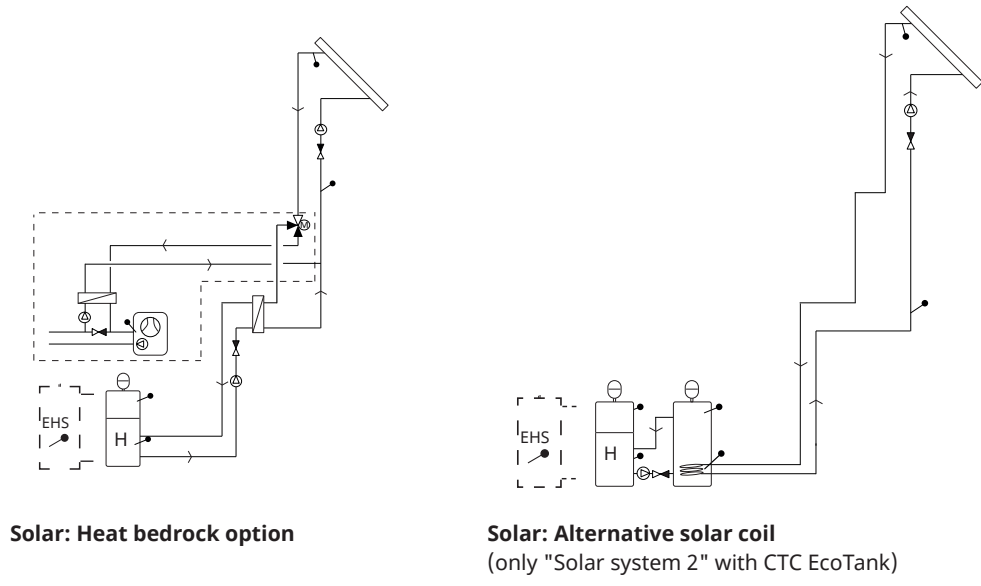
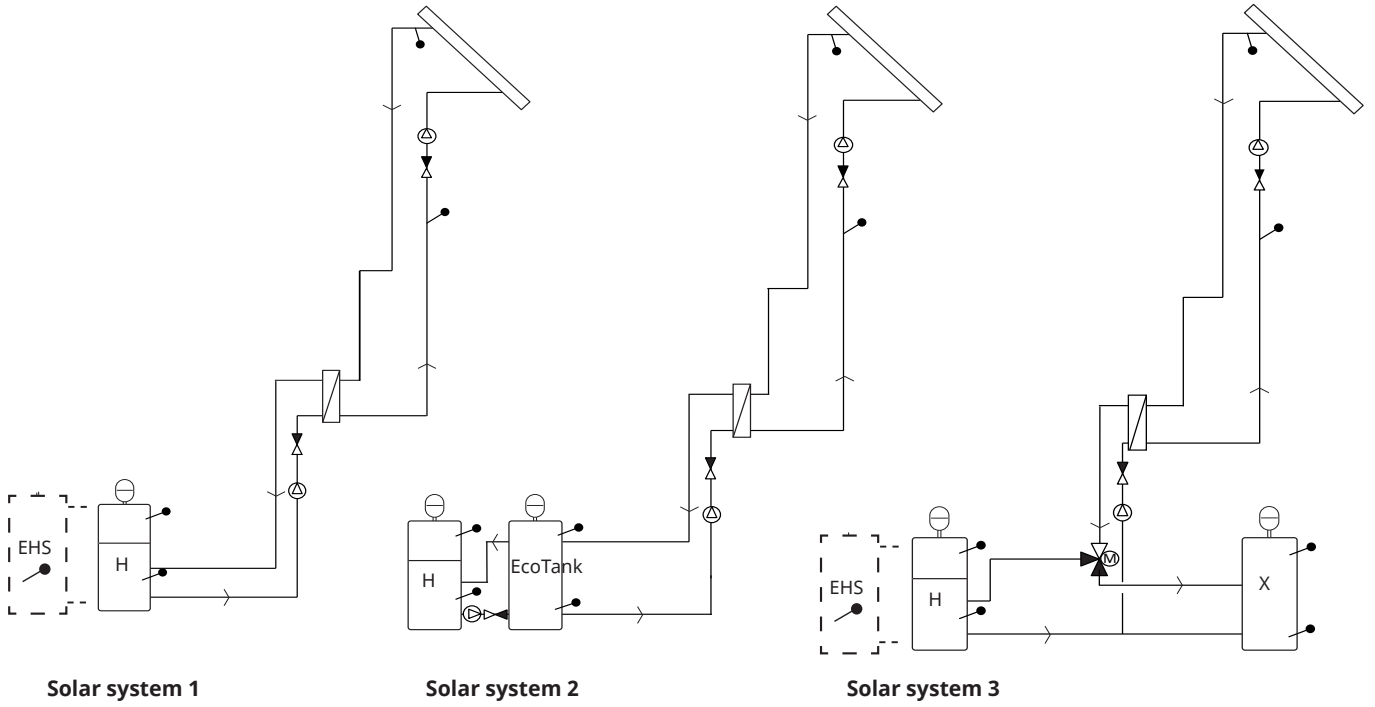

The picture shows the possible connections. The installation engineer fits expansion tank, safety valves, bleeders, etc. and sizes the system.

2.1.2 EcoSol - Example CTC EcoHeat and CTC EcoZenith i255 H/L

CTC EcoHeat and CTC EcoZenith i255 H/L have a water volume of 223 litres with layered disc and solar output. Solar output (3/4) is a part of EnergyFlex.

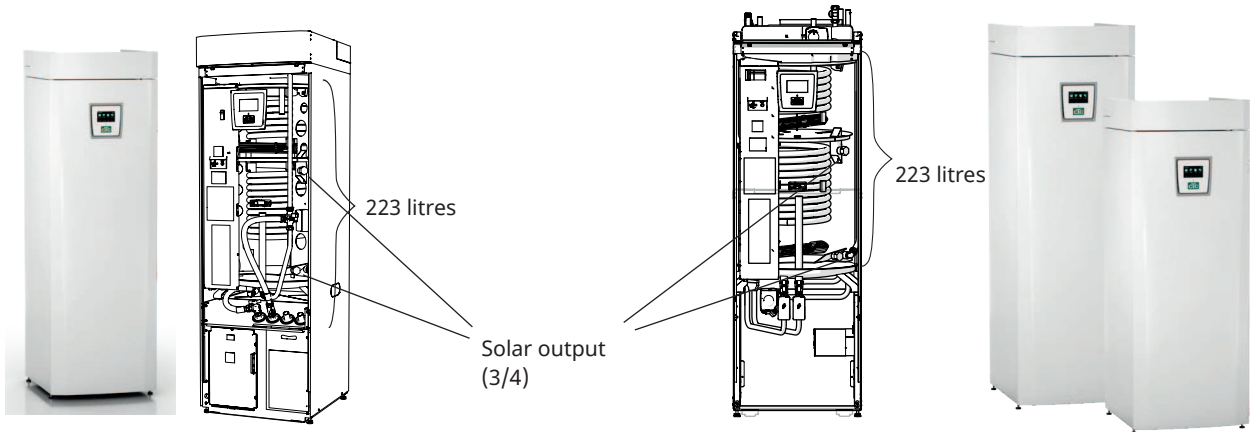

CTC EcoHeat 400
(223 litres with layered disc and solar output).

CTC EcoZenith i255 H/L
(223 litres with layered disc and solar output).

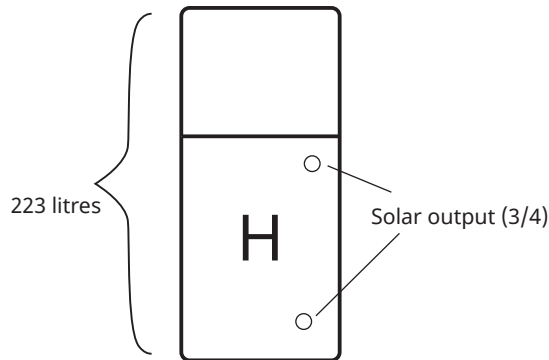

H. Symbol for tank volume in CTC EcoHeat 400 and CTC EcoZenith i255.

The tank in the CTC EcoHeat 400 and CTC EcoZenith i255 will be designated as H-tank (main tank).

Energy can be collected through the solar outputs (solar panels, wood-fired boiler) or generated (swimming pool).

Available as accessories are pre-bent pipes with couplings and insulation to facilitate installation.

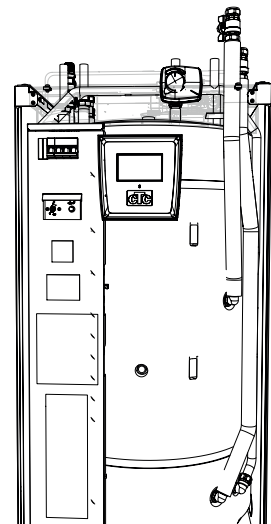

The EnergyFlex kit 400 pipe kit accessory fitted to H-tank.

3. System structure

The various systems that can be connected to the product are shown here.

3.1 Solar Panel

The number of solar panels which can be connected depends on the volume of water in the product/tanks to which the solar panels are to be connected. These diagrams are just basic outlines, so the exact placement may differ in reality. The system should be supplemented with bleeders, expansion tanks and safety valves etc. in suitable locations. A list of components is provided at the end of this chapter.

If the "Recharging of bedrock" function is selected, you can set the number of degrees by which the solar panel should be warmer than the brine fluid in the bedrock for charging to start. If the panel is charging or can charge the tank, tank charging is prioritised.

For menu settings, refer to the "Installer/Settings/Solar Panels" section.

3.1.1 Solar system 1

System design with solar heating only for H-tank (CTC EcoHeat 400/CTC EcoZenith i255) or for EHS-tank (other EnergyFlex models).

Charging conditions (main conditions, factory settings)

Charging starts when the solar panel sensor (B31) is 7 °C warmer than the H-tank sensor (B6) or EHS-tank sensor (B47).

Charging stops when there is a difference of 3 °C between the solar panel sensor and tank sensor.

Set the temperature difference at which charging of the bedrock should start. The solar panel must be this many degree warmer than the brine in the borehole for charging to start. If the panel is charging or can charge the tank, tank charging is prioritised.

3.1.2 Solar system 2

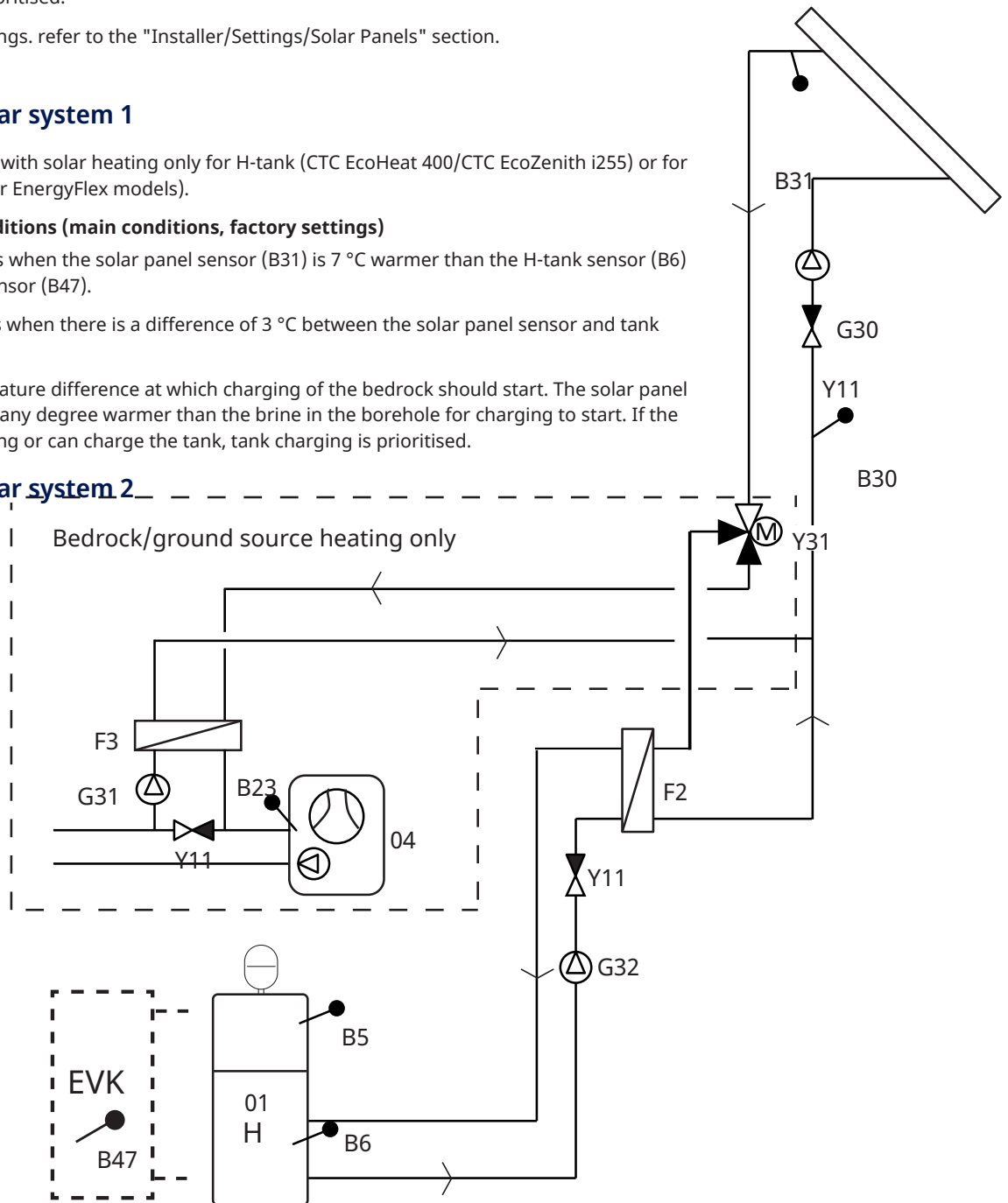

The picture shows the possible connections. The installation engineer fits expansion tank, safety valves, bleeders, etc. and sizes the system.

System design with H-tank (CTC EcoHeat 400/CTC EcoZenith i255) and CTC EcoTank (buffer tank). It is not possible to connect an EHS-tank to this system.

This system allows for a larger solar collector area since it carries a greater volume of water and the energy can be stored in the bedrock.

Charging conditions (main conditions, factory settings)

Charging starts when the solar panel sensor (B31) is 7 °C warmer than the EcoTank sensor (B42).

Charging stops when there is a difference of 3 °C between the solar panel sensor and EcoTank sensor.

Charging from CTC EcoTank to H-tank compares the CTC EcoTank sensor (B41) with the H-tank sensor (B6).

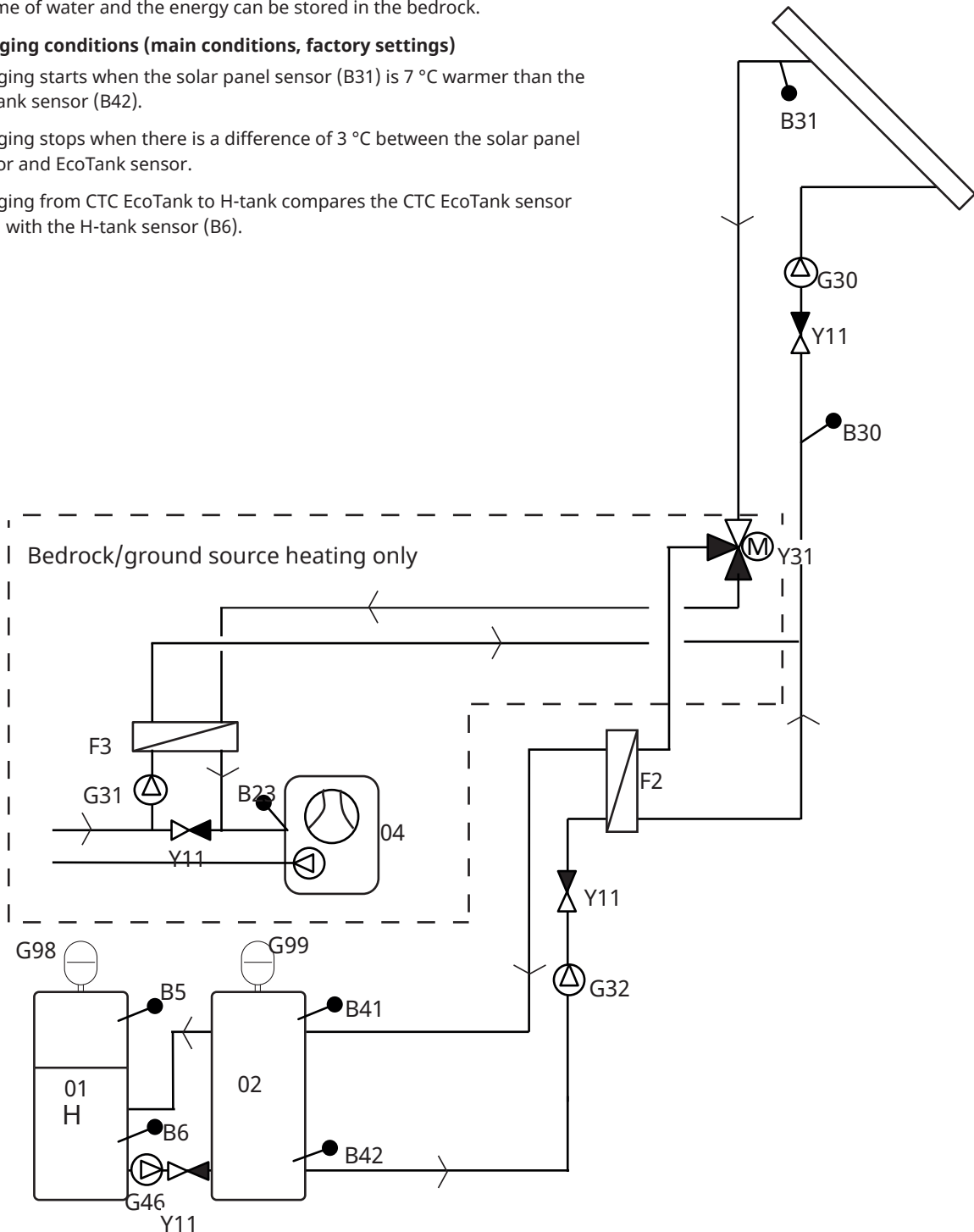

The picture shows the possible connections. The installation engineer fits expansion tank, safety valves, bleeders, etc. and sizes the system.

3.1.3 Solar system 2b with solar coil

System design with H-tank (CTC EcoHeat 400/CTC EcoZenith i255) and CTC EcoTank (buffer tank). It is not possible to connect an EHS-tank to this system.

This system allows for a larger solar collector area since it carries a greater volume of water and the energy can be stored in the bedrock.

Charging conditions (main conditions, factory settings)

Charging starts when the solar panel sensor (B31) is 7 °C warmer than the EcoTank sensor (B42).

Charging stops when there is a difference of 3 °C between the solar panel sensor and EcoTank sensor.

Charging from CTC EcoTank to H-tank compares the CTC EcoTank sensor (B41) with the H-tank sensor (B6).

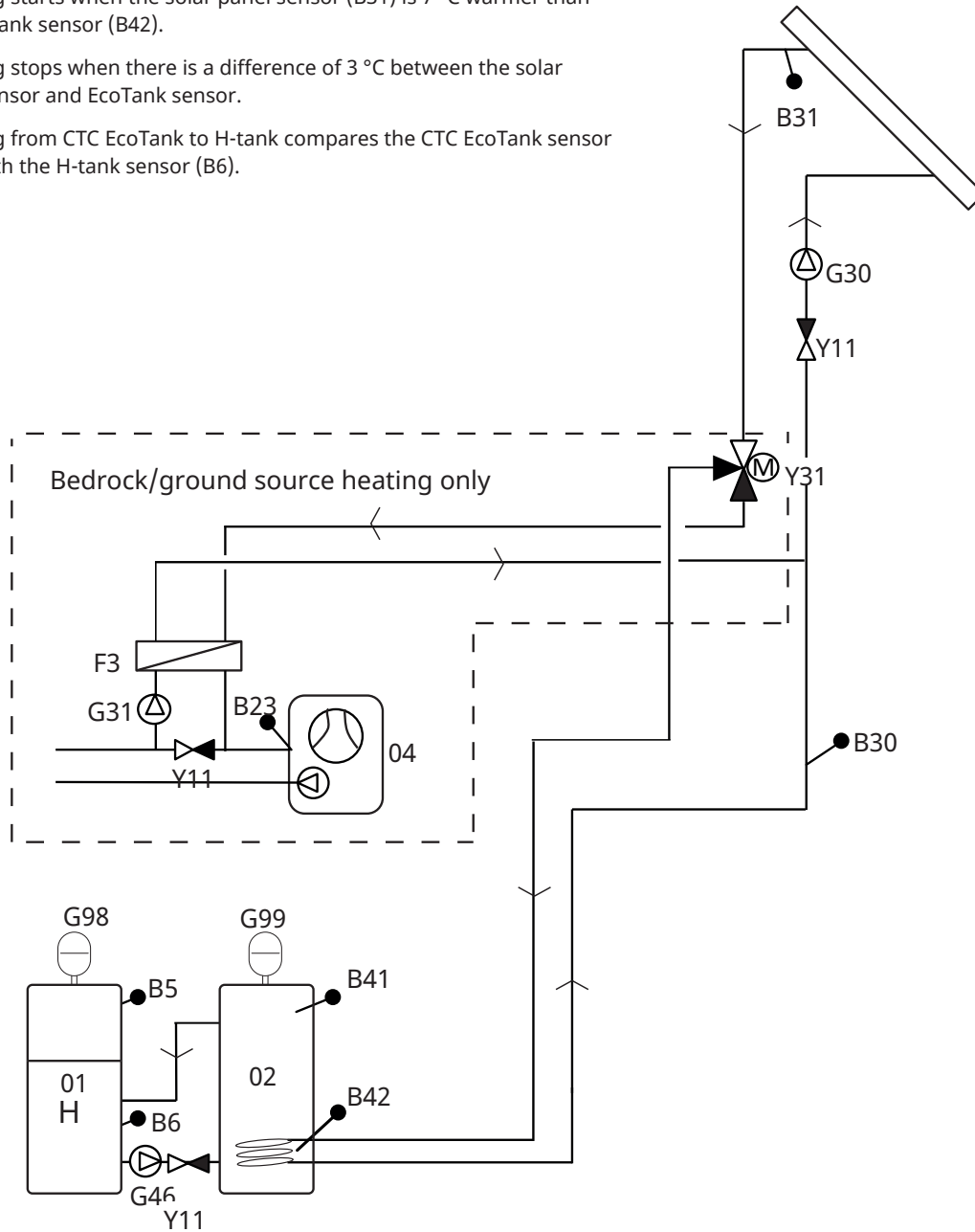

The picture shows the possible connections. The installation engineer fits expansion tank, safety valves, bleeders, etc. and sizes the system.

3.1.4 Solar system 3

H-tank (CTC EcoHeat 400/CTC EcoZenith i255) or EHS-tank (for other EnergyFlex models) with an extra volume tank (X volume, which may be an accumulator tank/pool, etc.). This system allows for a very large solar collector surface since it carries a greater volume of water.

Select this option if you want to prioritise the H-tank/EHS-tank or X-volume (03).

If X-volume is a connected pool, its chlorinated water should be separated by means of a pool exchanger fitted between 3-way valve Y30 and the pool. X-volume sensors (B41 and B42) must then be placed in the pool.

Charging conditions (main conditions, factory settings)

Charging starts when the solar panel sensor (B31) is 7 °C warmer than the EcoTank sensor (B42) or the H-tank sensor (B6) or EHS-tank sensor (B47).

Charging stops when there is a difference of 3 °C between the solar panel sensor and EcoTank sensor.

Exchange will take place when the prioritised tank reaches its charge temperature.

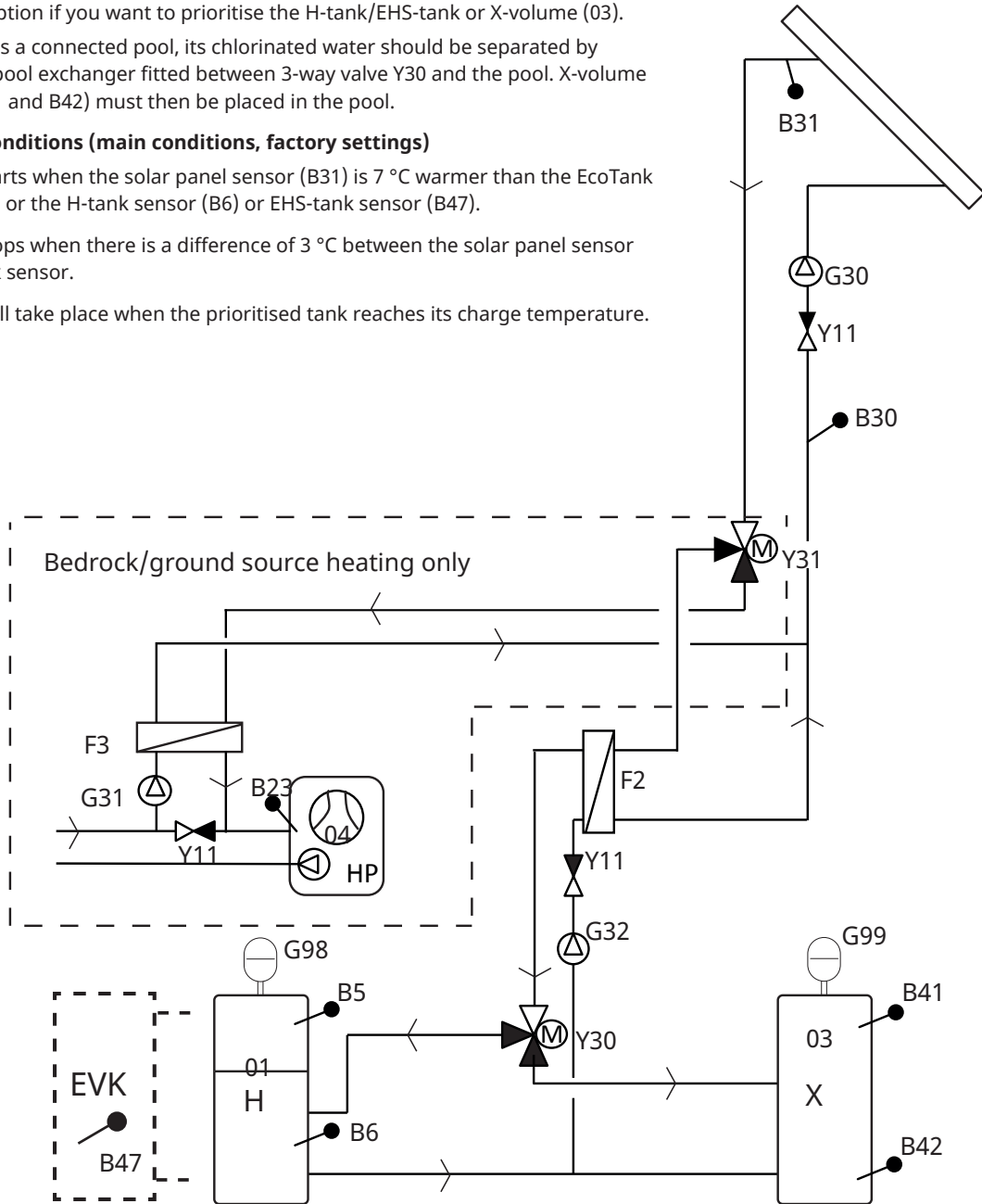

The picture shows the possible connections. The installation engineer fits expansion tank, safety valves, bleeders, etc. and sizes the system.

3.1.5 System option: bedrock heating

Bedrock charging can be activated in "Solar systems 1, 2 and 3".

See the figures below for pipe installation of 3-way valve Y31.

1. Flow from solar collector
2. Flow to tank
3. Flow to bore hole

3-way valve for bedrock heating must be installed with normal flow to the tank (2). The valve is then without power (NC).

When relay receives power, the valve will switch flow to the bedrock (3) and also start the brine pump (G31).

For "Recharging of bedrock" menu settings, refer to the "Installer/Settings/Solar Panels/Recharging of bedrock" section.

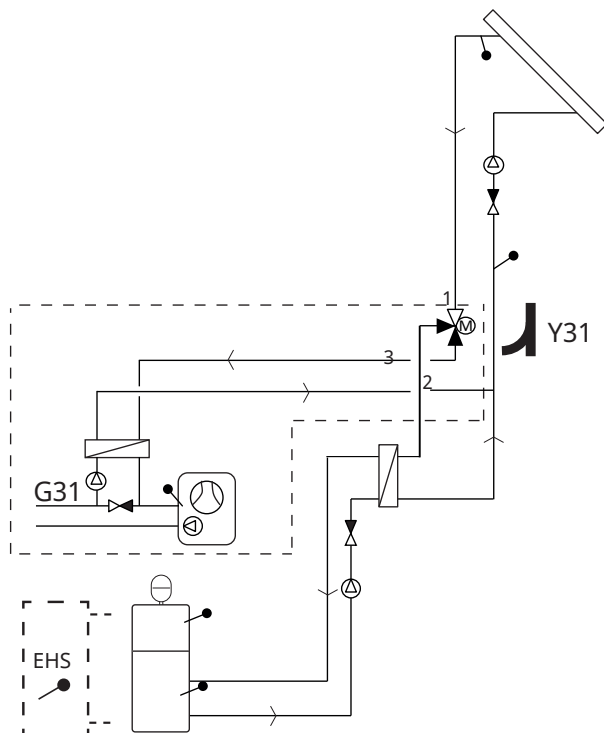
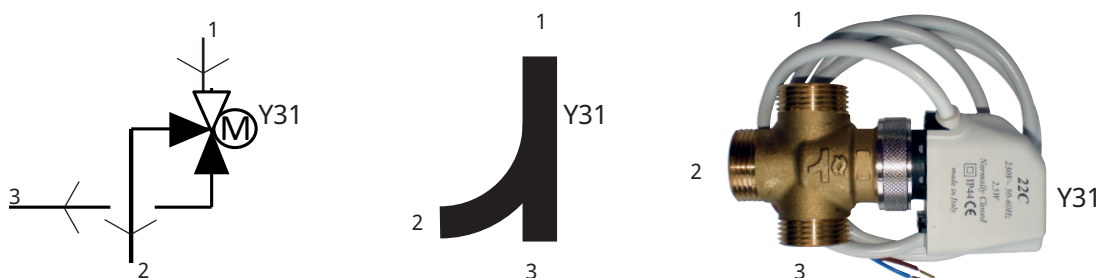

Example of bedrock charging with "Solar system 1".

Bedrock charging can also be activated in "Solar systems 2 and 3".

The picture shows the possible connections. The installation engineer fits expansion tank, safety valves, bleeders, etc. and sizes the system.

3.2 Pool

A pool can be connected to the system using a 3-way valve (Y50). A heat exchanger should be fitted to separate the liquids.

When the pool is heated, the 3-way valve (Y50) changes direction and the pool pump (G51) starts.

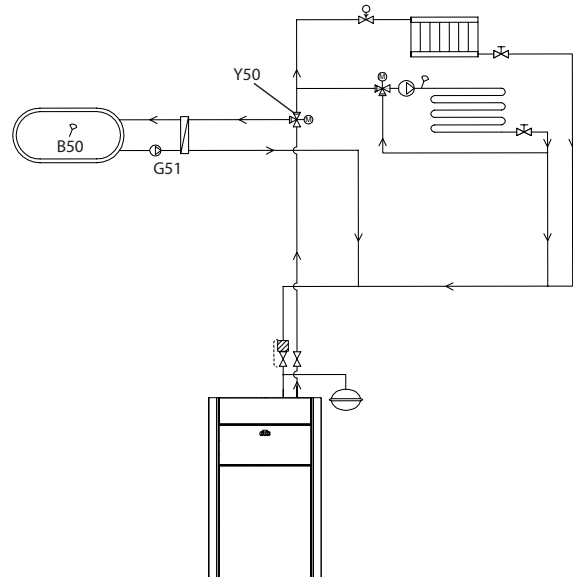

3.3 Diff thermostat function

The diff thermostat function is used to transfer heat from, for example, a buffer tank or existing wood boiler to an H-tank or EHS-tank.

The function compares the temperatures in the tanks. When it is warmer in the buffer tank, charging is started to the main tank/EHS-tank.

NB: For certain heat sources, such as solid fuel boilers, automatic chargers are recommended for, among other things, preventing condensation in the fire box.

The diff thermostat function cannot be used with "Solar system 2" (system with CTC EcoTank). This is because the same circulation pump (G46) is used.

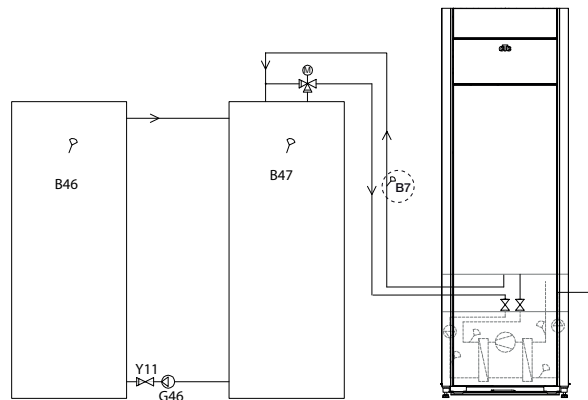

3.4 DHW circulation (DHW circ)

The function allows DHW to circulate in the pipes between the taps and the DHW tank, ensuring that the DHW is hot when the taps are opened.

DHW circulation is connected as shown in the schematic diagram.

Circulation pump (G40) is used to circulate the hot water.

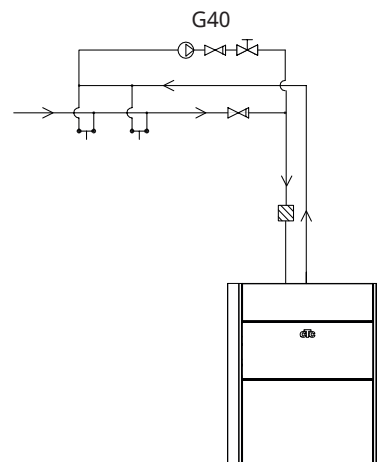

The picture shows the possible connections. The installation engineer fits expansion tank, safety valves, bleeders, etc. and sizes the system.

3.5 Parts list

Designation	Designation	Comment
01	H-tank	Main tank (EcoHeat 400/EcoZenith i255).
02	EcoTank	Buffer tank (CTC EcoTank or similar).
03	X-volume	Extra volume tank (or pool)
04	Heat pump	Cooling module in CTC EcoHeat, GS 600, GSi 600 or CTC EcoPart.
05	Tank for differential thermostat function	The water volume in the wood-burning system that energy is taken from with the differential thermostat function.
B5	Upper sensor M-tank	Measures the temperature in top section of EcoHeat/EcoZenith (factory-fitted)
B6	Lower sensor M-tank	Measures the temperature in bottom section of EcoHeat/EcoZenith (factory-installed)
B23	Brine sensor	Measures the brine temperature in the heat pump (factory-installed)
B30	Sensor solar panel in	Measures the return temperature to the solar panel, installed in expansion card.
B31	Sensor solar panel out	Measures the temperature from the solar panel, installed in expansion card.
B41	Upper X-volume/EcoTank sensor	Measures the temperature in the top section of the X-volume/EcoTank, installed in expansion card.
B42	Lower X-volume/EcoTank sensor	Measures the temperature in the bottom section of the X-volume/EcoTank, installed in extension card.
B46	Sensor for differential thermostat function	Installed in the heat pump/indoor module.
B47	External heat source (EHS) sensor	Measures the temperature in the EHS-tank.
B50	Sensor pool	Installed in expansion card.
F2	Solar/tank heat exchanger	Heat exchanger for charging the tank.
F3	Solar/brine heat exchanger	Heat exchanger for charging the brine.
G30	Circulation pump solar panel	Pump from exchanger to solar panel, fitted in expansion card
G31	Circulation pump borehole charging	Pump from brine to exchanger, installed in expansion card.
G32	Circulation pump heat exchanger	Pumps from tank to exchanger, installed in expansion card.
G40	Circulation pump for DHW circ.	Hot water circulation during the DHW circ. function.
G46	Pump tank transfer	Pumps between H-tank/EHS-tank and EcoTank/Tank for diff thermostat function.
G50/G51	Circulation pumps, pool	
G98/G99	Expansion vessel	
Y11	Non return valve	
Y30	Valve 2 tanks	Diverting valve, charging M-tank or X-volume, installed in expansion card.
Y31	Brine 3-way valve	Diverting valve, charging brine or tank, installed in expansion card.
Y50	3-way valve, pool	

4. Installation

Installation and connection must be undertaken by a qualified electrician. All wiring must be installed according to applicable local regulations.

Open the control unit by undoing the four screws and pushing the plastic cover to the side. Install the power supply, circulation pumps, valves and sensors.

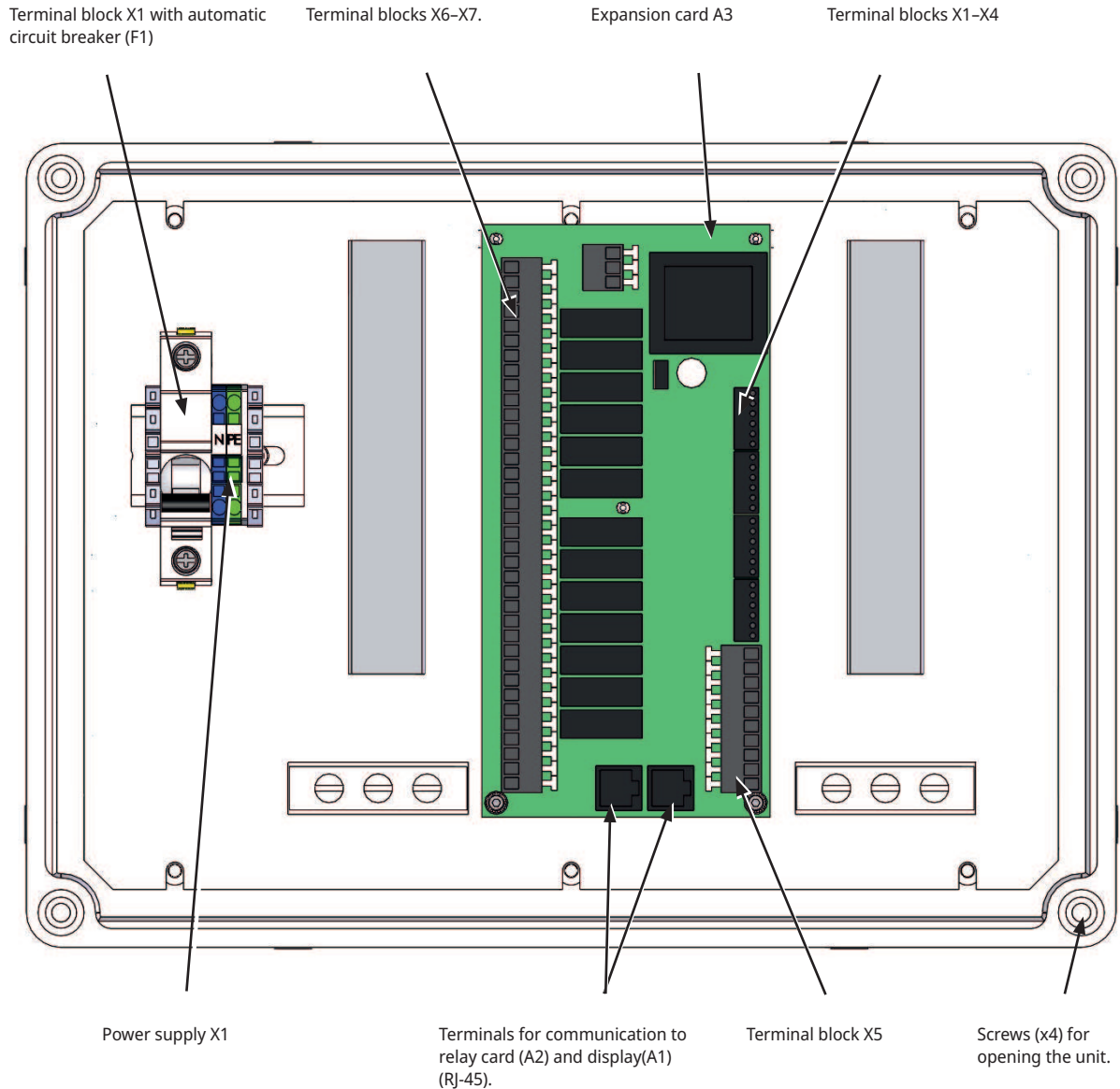

NB: Do not touch the PCB's components. The PCB can be damaged by static discharge.

4.1 Safety switch

The installation should be preceded by an omnipolar safety switch according to overvoltage category III, which ensures disconnection from all electric power sources.

4.2 Communication between extension card and main product

Use the RJ-45 cable provided as the communication cable. This must be installed between the extension card/solar control and the relay and display cards in the main product, from which control takes place. Remove the existing RJ-45 cable between the relay and display cards and connect the RJ-45 cable provided.

Connection communication cable (see image):

- Relay card A2 -> Expansion card A3
- Expansion card A3 -> Display card A1

4.3 High voltage

Supply:

230 V 1N~.

Max. fuse size (group fuse) 10A.

Connected to terminal block marked L1, N, PE

4.3.1 Pump, solar panel (G30, PWM) Wilo Stratos Para

230 V 1N~

Circulation pump G30 is powered separately (not from this unit).

The solar PWM pumps (G30 and G32) of model WILO Stratos PARA differ from the other PWM pumps. If the PWM control signal is interrupted, the solar pumps stop, whereas the other PWM pumps work at 100% power if the signal is interrupted.

The PWM control signal is connected to the following terminal blocks:

Expansion card X5:

Note the cable colours!

PWM+:	white	Terminal block X5: 1
GND:	brown	Terminal block X5: 2

Check the function by test running the pump in the "Installer/Service/Function test/Solar" menu in the control system.

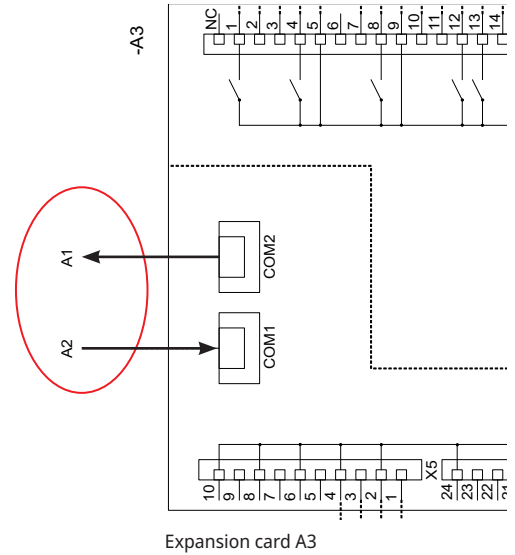

4.3.2 Circulation pump, solar collector (G30) Grundfos UPM3 Solar

230 V 1N~

The circulation pump is connected to the following terminal blocks:

(G30) Circulation pump, expansion card X5:

Note the cable colours!

PWM+:	brown	X5 pole 1
GND:	blue	X5 pole 2

Check the function by test running the pump in the "Installer/Service/Function test/Solar" menu in the control system.



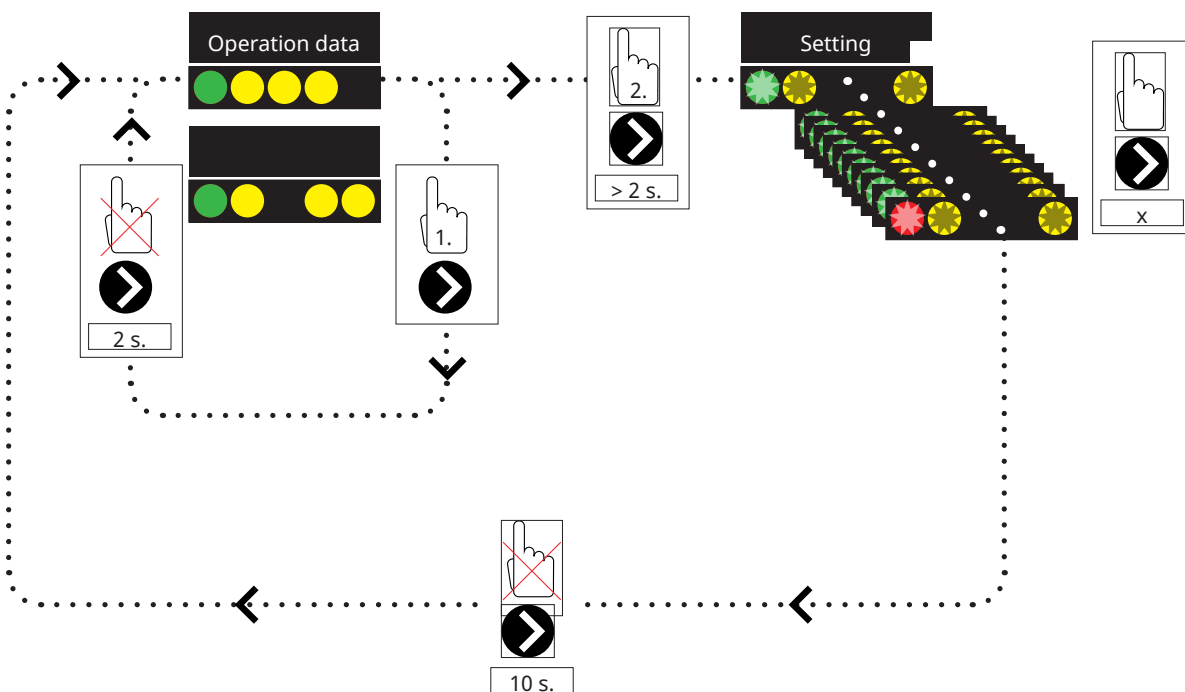

The pump must be set to PWM C profile (default)



1. Briefly press the circulation pump arrow to show the operating mode to which the pump is set. After 2 seconds, the operational information screen will be displayed again.









2. Pressing the circulation pump arrow for 2 seconds will cause the LEDs to flash and the mode setting can then be changed. Press repeatedly until the desired mode flashes. After 10 seconds, the operational information screen will be displayed again.

Operation data:



	Standby (flashing)
	0% - P1 - 25%
	25% - P2 - 50%
	50% - P3 - 75%
	75% - P4 - 100%

Selecting mode setting

Control Mode	Mode	xx-75	xx-105	xx-145	LEDs
Constant Curve		4.5 m	4.5 m	6.5 m	
Constant Curve		4.5 m	5.5 m	8.5 m	
Constant Curve		6.5 m	8.5 m	10.5 m	
Constant Curve		7.5 m	10.5 m	14.5 m	

Control Mode	Mode	xx-75	xx-105	xx-145	LEDs
PWM C Profile					
PWM C Profile					
PWM C Profile					
PWM C Profile					

Alarm info:

	Blocked
	Supply voltage low
	Electrical error

4.3.3 Pump bore hole charging (G31, on/off)

230 V 1N~.

Circulation pump G31 is connected to the following terminal blocks:

Expansion card X6:

Note the cable colours!

Phase:	brown	Terminal block X6:8
Zero:	blue	Terminal block X6:11
Earth:	yellow/green	Terminal block X6:10

Check the function by test running the pump in the "Installer/Service/Function test/Solar" menu in the control system.

4.3.4 Pump, intermediate heat exchanger solar panels (G32) PWM

230 V 1N~.

Pump G32 is powered separately (not from this unit).

The PWM control signal is connected to the following terminal blocks:

Expansion card X5:

Note the cable colours!

PWM+:	white	Terminal block X5:3
GND:	brown	Terminal block X5:4

Check the function by test running the pump in the "Installer/Service/Function test/Solar" menu in the control system.



4.3.5 Pump tank transfer (G46, on/off)

230 V 1N~.

Circulation pump G46 must be connected to relay cards in EcoZenith i255, EcoHeat 400, GS 600 and GSi 600 (refer to the wiring diagram for each product).

Circulation pump G46 must be connected to the extension card in the EcoZenith i360.

Note the cable colours!

Phase:	brown	Terminal block A:11 (EcoZenith i255, GS 600, GSi 600) Terminal block A:12 (EcoHeat 400)
Zero:	blue	
Earth:	yellow/green	

Check the function by test running the pump in the menu "Installer/Service/Function test/Diff thermostat function" or "Solar" in the control system.

4.3.6 Pool

4.3.6.1 Circulation pumps, pool (G50) and (G51)

230 V 1N~.

Both pumps (G50) and (G51) must be connected to the following terminal blocks on extension card X7:

Phase:	brown	Terminal block X7:33
Zero:	blue	Terminal block X7:35
Earth:	yellow/green	Terminal block X7:34

Pole 33 must be connected to the external connection box that distributes voltage to the charge pump (G50) and circulation pump (G51).

4.3.6.2 3-way valve (Y50)

Control voltage	Black	Terminal block X7:24
Phase	Brown	Terminal block X7:25
Zero	Blue	Terminal block X7:26

Check the function by test running the pump in menu "Installer/Service/Function test".

4.3.7 Valve 2 tanks (Y30)

230 V 1N~.

Diverting valve Y30 is connected to the following terminal blocks:

Extension card X6:

Control voltage:	black	Terminal block X6:4
Phase:	brown	Terminal block X6:5
Zero:	blue	Terminal block X6:7

Check the function by test running the valve in the menu "Service/Function test/Solar" in the control system.

4.3.8 Valve bedrock (Y31)

230 V 1N~.

Diverting valve Y31 is connected to pump G31 on the following terminal blocks:

Extension card X6:

Control voltage:	black	Terminal block X6:8
Phase:	brown	Terminal block X6:9
Zero:	blue	Terminal block X6:11

Valve 582581001 (see image) must only be connected with relay output, X6 pole 8 and neutral, X6 pole 11

Check the function by test running the valve in the menu "Service/Function test/Solar" in the control system.



582581001 22 3/4"

4.4 Sensor installation

Depending on the system that is to be connected, 3–6 sensors are required. The sensors used are PT1000 and NTC NTC22k type sensors. Some sensors are connected at the factory. Connect each sensor to the correct terminal block on the control unit. Ensure that the sensors are installed in the correct location and with good contact. Incorrectly installed sensors result in the system not working as intended.

There are few things to bear in mind when installing sensors:

- Ensure that the sensors are mounted with good contact. If possible, use some type of thermal conduction paste on the contact surface.
- To achieve optimum function, ensure that the sensors are insulated.
- Some of the sensors will need to be extended. The following cable types must be used depending on the length of the extension cable:
 - Up to 15 m → 2 x 0.5m².
 - Up to 50 m → 2 x 0,75m².
- Avoid positioning sensor cables next to high-voltage cables.

! Only use sensors in the solar collector that are suitable for a temperature of 180°C. (Red colour coding)

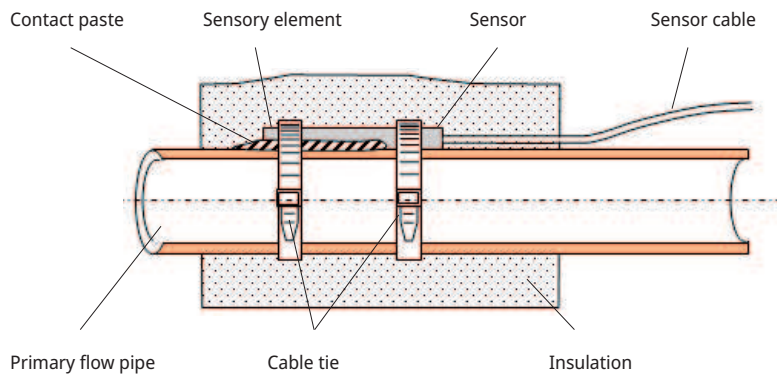
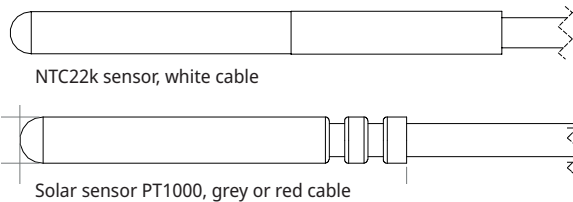

4.4.1 Sensor connection (extra low voltage protection)

The sensors that form part of each system solution should be fitted to the PCB/ terminal block as follows: All sensors are temperature sensors.

Sensor, Solar panel In (B30, PT1000)

Measures the return temperature to the solar panel. Mounted on the copper piping on the return line to the solar collectors. Secured with a heat-resistant cable tie and thermal conduction paste.

Connected to expansion card X1:

Terminal block X1: 3

Terminal block X1: 4

Sensor solar panel out (B31, PT1000)

180 °C Red colour coding:

Measures the temperature from the solar collector. It is important for this sensor to be installed so that it detects the panel temperature even when fluid is not circulating. This sensor is installed in the solar collector. For the exact positioning, see the solar panel manual.

If it is difficult to position the sensor in the solar collector, the "Sensor test" function should be activated.

Connected to expansion card X1:

Terminal block X1: 1

Terminal block X1: 2

X-volume/buffer tank/EcoTank sensor, upper (B41, NTC22k)

Measures temperature in the upper part of the tank. Mounted in the upper part of the acc. tank or in the pool.

Connects to extension card X2:

Terminal block X2: 9

Terminal block X2: 10

X-volume/buffer tank/EcoTank sensor, lower (B42, NTC22k)

Measures temperature in the lower part of the tank. Mounted in the lower part of the acc. tank or in the pool.

Connected to the expansion card X2:

Terminal block X2: 11

Terminal block X2: 12

 Only use sensors in the solar collector that are suitable for a temperature of 180°C. (Red colour coding)

Diff thermostat function sensor, lower (B46, NTC22k)

Measures the temperature in the lower part of the EcoTank.

Mounted in the lower part of the EcoTank.

Connects to EcoHeat 400/EcoZenith i255.

Terminal block G65

Terminal block G66

External heat source (EHS) tank sensor (B47, NTC22k)

Measures the temperature in the EHS-tank.

For installation in the EHS-tank

Connects to relay card A2.

Terminal block G67

Terminal block G68

Sensor, Pool (B50, NTC22k)

Measures the temperature in the pool water.

Positioning: In the pool water.

Connected to the expansion card X3:

Terminal block X3:15

Terminal block X3:16

4.4.2 Factory-fitted sensors

H-tank sensor upper/DHW tank sensor (B5, NTC22k)

- H-tank sensor upper (CTC EcoHeat and EcoZenith i255):
Measures the temperature in the upper tank.
- DHW tank sensor (CTC GS 600/GSi 600/EcoZenith i360):
Measures the temperature in the DHW tank.

H-tank sensor lower (B6, NTC22k)

Measures the temperature in lower part of CTC EcoHeat/EcoZenith i255.

Brine temperature sensor (B23, NTC22k)

Measures the brine temperature in the heat pump. Factory-installed in EcoHeat/EcoPart.

4.4.3 Resistance level of the temperature sensors

The resistance that the sensors need to have at different temperatures is described below. The table can be useful for identifying a poor sensor when troubleshooting.

PT1000

Temperature °C	Resistance Ω
-10	960
0	1000
10	1039
20	1077
30	1116
40	1155
50	1194
60	1232
70	1271
80	1309
90	1347
100	1385
120	1461
140	1535

NTC 22 kΩ

Temperature °C	NTC 22 k Resistance Ω
130	800
125	906
120	1027
115	1167
110	1330
105	1522
100	1746
95	2010
90	2320
85	2690
80	3130
75	3650
70	4280
65	5045
60	5960
55	7080
50	8450
45	10130
40	12200
35	14770
30	18000
25	22000
20	27100
15	33540
10	41800
5	52400
0	66200
-5	84750
-10	108000
-15	139000
-20	181000
-25	238000

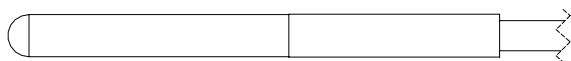

NTC22k sensor, white cable

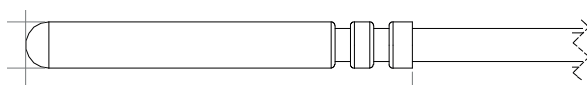

Solar sensor PT1000, grey or red cable

4.5 Wiring diagram

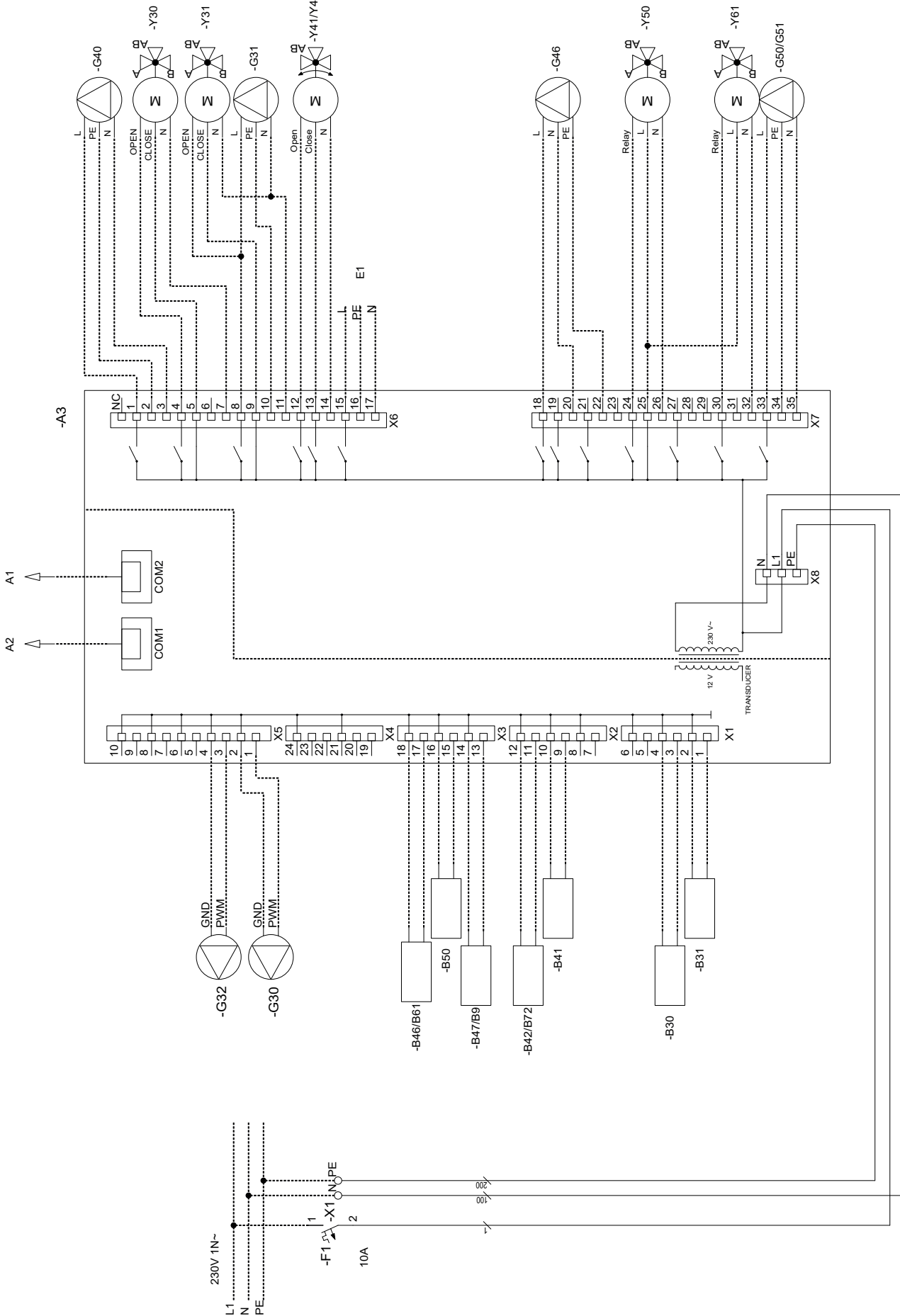

4.6 Connection table for Expansion Card A3

This table shows the component connections for Extension Card A3. (Also see the wiring diagram for the extension card).

Designation		Terminal block/ cable	
A1	Display	COM2	*
A2	Relay/main card	COM1	*
B9	Sensor external boiler	X3:13	*
B9	Sensor external boiler	X3:14	*
B31	Solar panel sensor out	X1:1	*
B31	Solar panel sensor out	X1:2	*
B30	Solar panel sensor In	X1:3	*
B30	Solar panel sensor In	X1:4	*
B41	Sensor, external buffer tank upper	X2:9	*
B41	Sensor, external buffer tank upper	X2:10	*
B42	Sensor, external buffer tank lower	X2:11	*
B42	Sensor, external buffer tank lower	X2:12	*
B46	Sensor, diff. thermostat	X3:17	*
B46	Sensor, diff. thermostat	X3:18	*
B47	Sensor, external heat source, tank	X3:13	*
B47	Sensor, external heat source, tank	X3:14	*
B50	Sensor pool	X3:15	*
B50	Sensor pool	X3:16	*
G30	Circulation pump, solar panel	X5:1	PWM
G30	Circulation pump, solar panel	X5:2	GND
G32	Pump, plate heat exchanger – solar energy	X5:3	PWM
G32	Pump, plate heat exchanger – solar energy	X5:4	GND
G40	Circulation pump for DHW circ.	X6:1	L
G40	Circulation pump for DHW circ.	X6:2	PE
G40	Circulation pump for DHW circ.	X6:3	N
G31	Pump, bore hole recharging	X6:8	L
G31	Pump, bore hole recharging	X6:10	PE

Designation		Terminal block/ cable	
G31	Pump, bore hole recharging	X6:11	N
E1	Relay, external boiler	X6:15	L
E1	Relay, external boiler	X6:16	PE
E1	Relay, external boiler	X6:17	N
G46	Charging pump	X7:18	L
G46	Charging pump	X7:20	N
G46	Charging pump	X7:22	PE
G50	Circulation pump, pool heating	X7:33	L
G50	Circulation pump, pool heating	X7:34	PE
G50	Circulation pump, pool heating	X7:35	N
G51	Circulation pump, pool heating	X7:33	L
G51	Circulation pump, pool heating	X7:34	PE
G51	Circulation pump, pool heating	X7:35	N
Y30	Diverting valve, solar, external buffer tank	X6:4	Open
Y30	Diverting valve, solar, external buffer tank	X6:5	Close
Y30	Diverting valve, solar, external buffer tank	X6:7	N
Y31	Brine diverting valve, solar	X6:8	Open
Y31	Brine diverting valve, solar	X6:9	Close
Y31	Brine diverting valve, solar	X6:11	N
Y41	Mixing valve, External heat source	X6:12	Open
Y41	Mixing valve, External heat source	X6:13	Close
Y41	Mixing valve, External heat source	X6:14	N
Y42	Mixing valve, External heat source	X6:12	Open
Y42	Mixing valve, External heat source	X6:13	Close
Y42	Mixing valve, External heat source	X6:14	N
Y50	3-way valve, pool	X7:24	Relay
Y50	3-way valve, pool	X7:25	L
Y50	3-way valve, pool	X7:26	N

* cable can be connected regardless of terminal block for component

5. Detailed menu descriptions



NB: This chapter describes the display menus that are included with Extension card EnergyFlex. Applies to main products shipped from 14/09/2020.



For more information about the design of the menu system, refer to the respective main product's "Installation and Maintenance Manual".

5.1 Navigate on the touchscreen

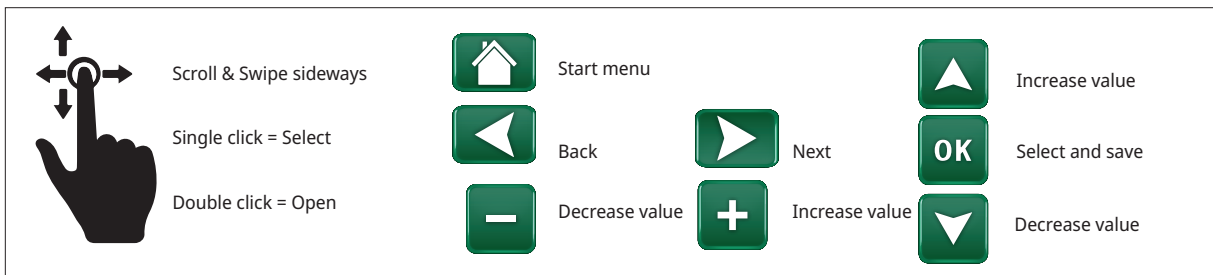

5.2 Start menu

This menu is the system's home screen. This provides an overview of the current operation data.

The system returns to this menu if no buttons are pressed within 10 minutes. All other menus can be accessed from this menu.

Click the symbol in the upper right corner of the start menu to get to the "Installer" menu.

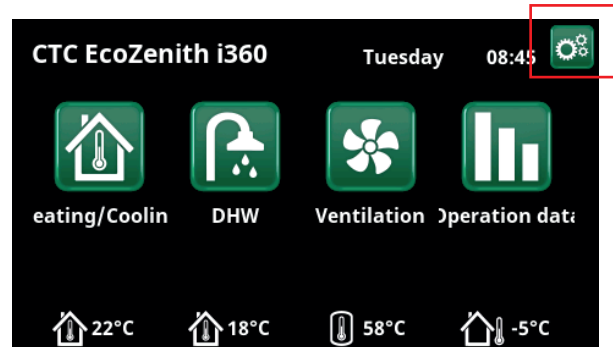

Start menu (model CTC EcoZenith i360).



Installer

The "Installer" menu contains four sub-menus:

- Display
- Settings
- Define
- Service

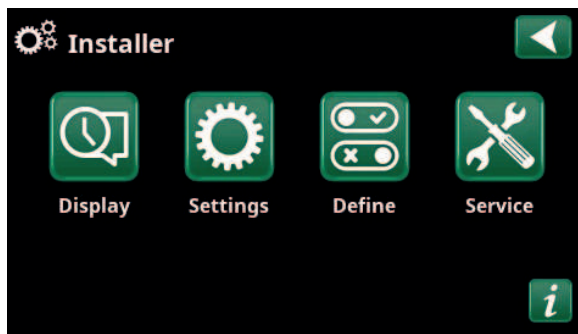

Menu: "Installer".



5.3 Define



For more information about possible system configurations, refer to the respective main product's "Installation and Maintenance Manual".



The menu rows shown in the menu screenshots below may vary depending on the model of heat pump/control product.

5.3.1 Def. Diff thermostat function

The diff thermostat function is used, for example, if you want to charge EcoZenith i255 from a water-jacketed stove or other heat source.

The function can also be used in a heating circuit with CTC GSi 600 or CTC EcoZenith i360, for example, when transferring heat from a buffer tank (e.g. CTC EcoTank) to an EHS-tank.

However, the diff thermostat function cannot be combined with "Solar system 2" with CTC EcoTank since the same circulation pump (G46) is used by both functions.

Diff thermostat function **No (Yes/No)**

Select "Yes" if diff thermostat function is to be used.

Blocking diff thermostat ext. config. **None (None/NC/NO)**

This menu defines the Normally Open (NO) or Normally Closed (NC) mode for the external control signal when controlling the function remotely.

For examples of normal mode settings, refer to the "Def. Remote Control" section of the "Installer/Define" chapter.

Information about the Differential thermostat function is shown in chapter "Operation info".

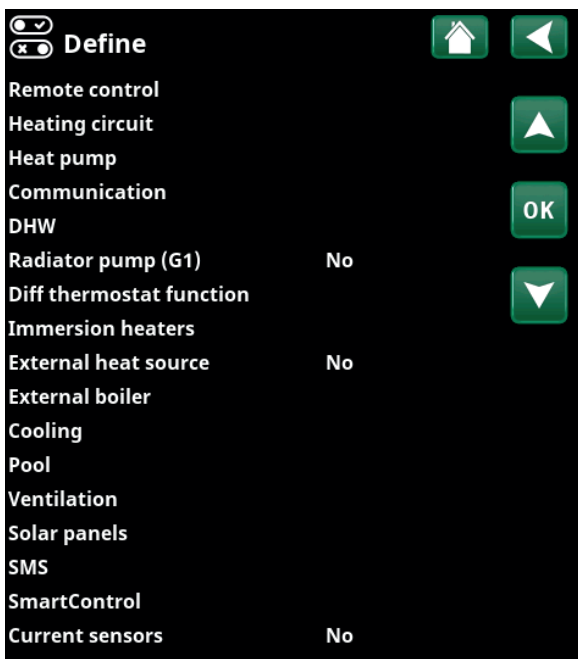

Menu: "Installer/Define".

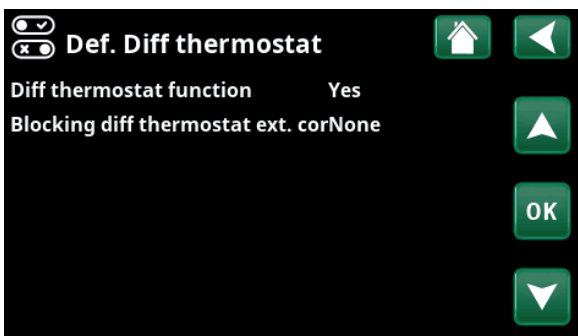

Menu: "Installer/Define/Diff thermostat".

5.3.2 Def. Pool

Pool **No (Yes/No)**

Select "Yes" to connect the pool to the heating circuit.

Block pool ext. config **None (None/NC/NO)**

This menu bar is displayed if an "Input" for remote control is defined for the "Block Pool" function in the "Installer/Define/Remote Control" menu.

This menu defines the Normally Open (NO) or Normally Closed (NC) mode for the external control signal when remotely controlling pool heating.

For more information about remotely controlling functions, refer to the main product's "Installation and Maintenance Manual".



Menu: "Installer/Define/Pool".

5.3.3 Def. Solar Panel

Refer to the "System Options EnergyFlex" chapter for more information on possible system options for solar panels.

Also see the schematic diagrams in the "System Design" chapter.

Solar Panels **No (Yes/No)**

Specify whether solar panels are used.

Recharging bedrock **No (Yes/No)**

Specify whether "Recharging of bedrock" is activated.

Alternate charging **No (Yes/No)**

This function activates "Solar system 3".

"Yes" means that you can choose to prioritise charging to EHS-tank/H-tank or X-volume.

EcoTank **No (Yes/No)**

This function activates "Sola system 2" with EcoTank buffer tank (or equivalent).

Panel connected to **coil (coil/exchanger)**

Specify whether there is a solar coil in the EcoTank or an intermediate exchanger is installed.

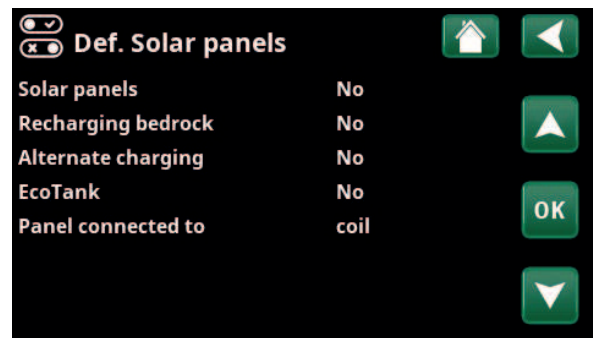

Menu: "Installer/Define/Solar Panels".

5.3.4 Def. DHW/DHW circulation

Define DHW circulation (DHW circ).

Refer to the "Define DHW" chapter in the main product's "Installation and Maintenance Manual".

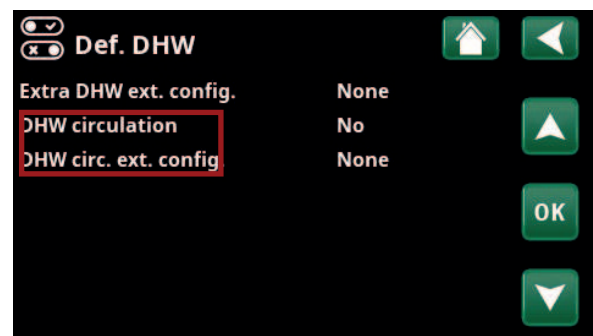

Menu: "Installer/Define/DHW".



5.4 Settings

The settings required for the heating circuit to function optimally are made under the "Settings/" menu.

i The menu rows shown in the menu screenshots below may vary depending on the model of heat pump/control product.

5.4.1 Settings Diff thermostat function

The function must be defined before the settings can be made (refer to the "Define/Diff thermostat function" section).

The diff thermostat function is used when transferring heat between two system tanks; for example, between a buffer tank (CTC EcoTank) and the CTC EcoZenith i255 main tank (H-tank) or an EHS-tank in a heating circuit with CTC GSi 600/EcoZenith i360.

For more information, refer to the "System Design" section.

Charge start diff temp °C 7 (3...30)

Set the temperature difference at which charging from the heat source should start. The heat source must be this many degree warmer than the tank temperature for charging to start.

Charge stop diff temp °C 3 (2...20)

Set the temperature difference at which charging from the heat source should stop. When the temperature difference between the product and the tank falls below this set value, charging stops.

Charge temperature °C 60 (10...80)

Set the maximum permissible temperature in the tank being charged. The charging stops if this temperature is exceeded.

Charge tank No (No/Yes)

Overcharging from the lower tank to the buffer tank starts when:

- Setting menu bar "Charge tank" = "Yes".
- "SmartGrid Low price" or "SmartGrid Overcap." is active and a temperature increase via SmartGrid is set in the lower tank.
- The heat pump charges the lower tank and the temperature in the lower tank is 5 °C higher than the previous set point* and the temperature in the buffer tank is 5 °C lower than the previous set point*.

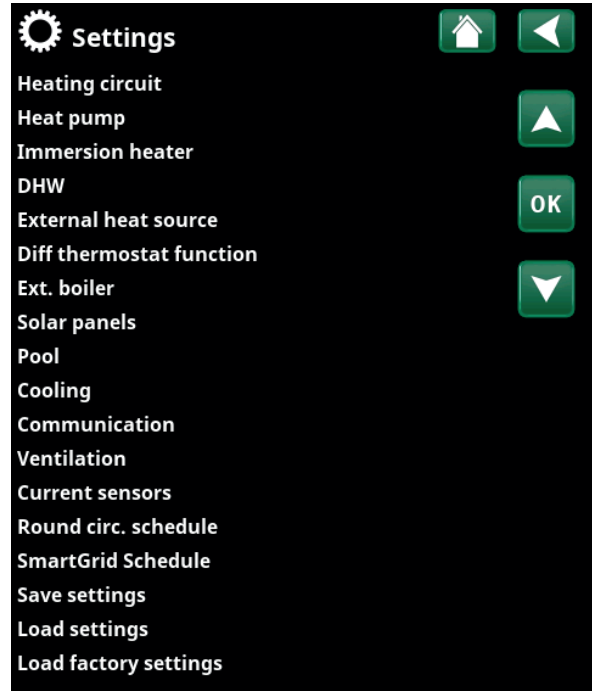

Menu: "Installer/Settings".

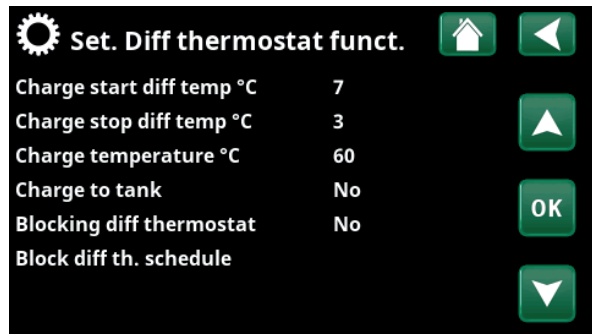

Menu: "Installer/Settings/Diff Thermostat".

*Previous setpoint means the setpoint before "SmartGrid Low Price" or "SmartGrid Overcap." was activated.

Overcharging to the buffer tank continues until:

- The heat pump stops charging the lower tank (the need to charge the tank has disappeared).
- The temperature in the lower tank has dropped to the setpoint.
- "SmartGrid Low Price/Overcap." is not active.

Block diff thermostat **No (No/Yes)**

"Yes" means the function can be activated via remote control.

Block diff th. schedule

Access function scheduling from the "Block diff th. schedule" row.

5.4.2 Settings Solar Panels

5.4.2.1 Solar basic settings

Charge start diff temp °C **7 (3...30)**

Set the temperature difference at which bedrock charging should start. The solar panel must be this many degrees warmer than the tank temperature for charging to start.

Charge stop diff temp °C **3 (3...30)**

Set the temperature difference at which solar heating charging should start. When the temperature difference between the solar panel and the tank falls below this set value, the charging stops.

Charge pump min % **20 (20...100)**

Specify the minimum permissible speed of the charge pump (G30; G32).

Sensor test active **No (Yes/No)**

Specify whether or not the solar sensor test should be activated. If the solar panel sensor cannot be installed in such a way that the actual panel temperature can be detected, the charge pump needs to run for a while for the panel's fluid to have an effect on the sensor.

-Test/Pause, min **4 (1...20) /30 (80...180)**

Test (4): Specify the duration of the sensor test, so that hard-to-reach sensors can detect the correct temperature. The length of the sensor test should be as short as possible to prevent heat being drawn from the tank unnecessarily in situations when the solar panel cannot charge.

Pause (30): The time between the sensor tests is indicated here. A new sensor test will start after the pause.

-Winter break **No (Yes/No) Nov - Feb**

Specify the months during which sensor testing should be paused. During the winter, when the panel (as a rule) cannot heat the tank, there is no need to carry out sensor tests. A sensor test carried out at that time of year can lead to some tank heat being dumped in the solar panel, which should be avoided.

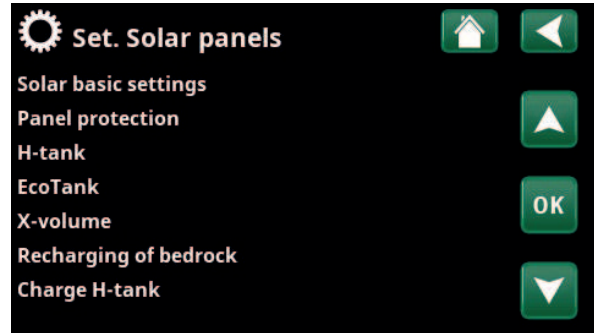

Menu: "Installer/Settings/Solar Panels".

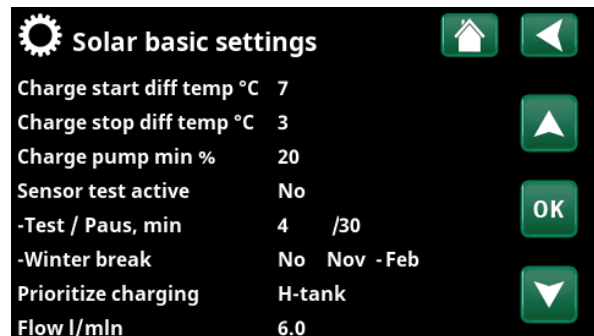

Menu: "Installer/Settings/Solar panels/Default settings, solar".

Prioritise charging:

H-tank/EHS-tank or X-volume

Specify whether H-tank/EHS-tank or X-volume (accumulator tank/pool) should be prioritised during charging (shown only if alternate charging is defined).

The options (charging from H-tank or EHS-tank) depend on the model of heat pump/indoor module.

Flow l/min 6.0 (0.1...50.0)

Specify the flow circulating through the solar collectors (read from the flow meter in the system unit). The flow must be read when the solar panel pump is running at 100%.

NB: The flow is used as the basis for calculating the power and cumulative energy. Incorrect flows will therefore produce incorrect values for these parameters. The pump can be set manually to 100% flow in the "Installer/Service/Function test" to take a reading.

5.4.2.2 Panel protection

This is where settings are made for the functions that protect the solar panels from overtemperatures and the risk of freezing.

Over temp protection panel No (Yes/No)

Activate the protection function to protect the solar panel overtemperatures. This is done by cooling the solar panel.

-max panel temp °C 120 (100...150)

Specify the maximum temperature that the panel may reach; after which the cooling function will start. When cooling is active, heat is dumped 1) in the borehole if there is borehole recharging and 2) then in the tanks up to their maximum permitted temperature.

When the temperature in the solar panel exceeds "max panel temp °C", the circulation pump will start and the text "cooling panel" will be displayed in "Operation Data" menu.

When the temperature in the solar panel drops while the temperature in the tank remains high, the circulation pump continues to work and the text "cooling tank" will be displayed in "Operation Data" menu. This will continue until the tank has reached 60 °C.

(Charge temperature, factory setting.)

Cool over temp in tank No (Yes/No)

If energy has been transferred to the tank in order to cool the panel, the function to cool the tank by conveying energy to the panel is activated here. This is to enable the system to receive panel cooling (e.g. on the next day).

-Tank cools down to °C 70 (50...80)

Specify the temperature that the tank is to be cooled after the overtemperature has been reached by charging. When this happens, "additional cooling" will be displayed in "Operation Data".

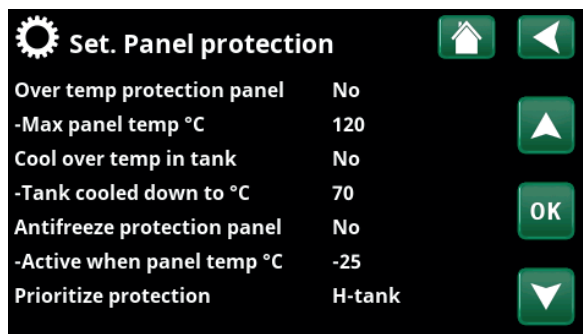

Menu: "Installer/Settings/Solar panels/Panel protection functions".

Antifreeze protection panel **No (Yes/No)**

In the winter, at extremely cold outdoor temperatures, there is a risk of the panels freezing (despite the use of antifreeze). The function to take heat from the tank to the panel is activated here.

-Active when panel temp °C **-25 (-30...-7)**

Specify the temperature in the solar collector at which the Antifreeze should start. When the panel sensor shows a temperature below the Antifreeze limit, the charge pump starts until the sensor temperature is 2 degrees warmer than the limit value (hysteresis 2 °C).

Prioritize protection **H-tank/EHS-tank or X-volume**

Specify the tank that the protection functions should protect.

This is only applicable if X-volume i "Solar system 3" is activated.

The options shown (H-tank or EHS-tank) depend on the model of heat pump/indoor module.

5.4.2.3 Settings H-tank/EHS-tank/ EcoTank/X-volume

The menu heading displayed (Settings H-tank or Settings EHS-tank) depends on the model of heat pump/indoor module.

Menu heading "Settings H-tank" is displayed for "Solar system 1-3".

Menu heading "Settings EHS-tank" is displayed for "Solar system 2".

Menu heading "Settings EcoTank" may be displayed for "Solar system 2".

Menu heading "Settings X-volume" may be displayed for "Solar system 3".

Charge temperature °C **60 (10...95)**

Set the maximum permitted temperature in the EHS-tank or H-tank. Charging stops once the set temperature has been reached.

Maximum tank temp °C **70 (60...125)**

If the solar panel temperature exceeds "max panel temp °C", the tank is permitted to be overcharged by the panel up to this set tank temperature.

This also requires that "Overtemp protection panel" is activated (refer to the "Settings. Panel protection functions" menu).

5.4.2.4 Recharging of bedrock settings

Recharging active **No (Yes/No)**

"Yes" activates the "Recharging of bedrock" function. The function is designed to protect the solar panel against overtemperatures, but it can also charge the bedrock with energy.

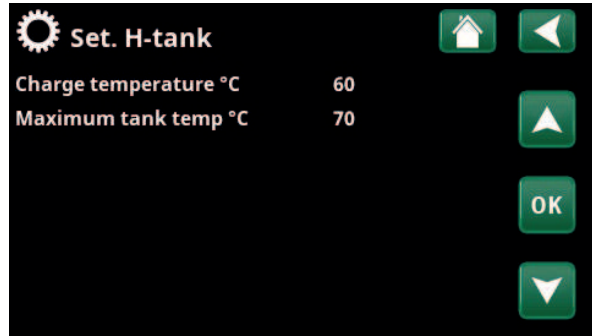

Menu: "Installer/Settings/Solar Panels/H-tank".

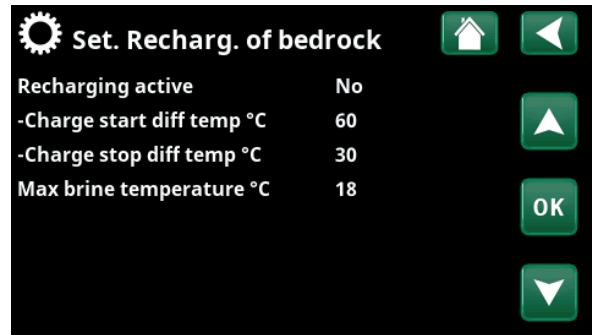

Menu: "Installer/Settings/Solar Panels/Recharging of bedrock".

-Charge start diff temp, °C 60 (3...120)

Set the temperature difference at which charging of the bedrock should start. The solar panel must be this many degrees warmer than the brine in the borehole for charging to start. If the panel is charging or can charge the tank, tank charging is prioritised.

-Charge stop diff temp, °C 30 (1...118)

Set the temperature difference at which charging of the bedrock should stop. When the temperature difference between the solar panel and the brine falls below this set value, the charging stops.

-Max permitted brine temp °C 18 (1...30)

Setting for the maximum permitted brine temperature. Charging of the borehole ceases when this value has been reached.

5.4.2.5 Charge H-tank settings

Function applicable to charging conditions between EcoTank and main tank (H-tank) in "Solar system 2".

However, this function cannot be combined with "Diff thermostat function" since the same circulation pump (G46) is used by both functions.

Charge start diff temp °C 7 (3...30)

Set the temperature difference at which charging to H-tank should start.

EcoTank in "Solar system 2" must be this many degree warmer than the H-tank for charging to start.

Charge stop diff temp °C 3 (2...20)

Set the temperature difference at which charging to H-tank should stop.

When the temperature difference between EcoTank and H-tank falls below this set value, charging stops.

Charge temperature °C 60 (10...80)

Set the maximum permitted temperature in the H-tank. Transfer stops once the set temperature has been reached.

5.4.3 Settings DHW circulation

Specify settings for DHW circulation (DHW circ).

Refer to the "Installer/Settings/DHW" chapter in the main product's "Installation and Maintenance Manual" for more information.

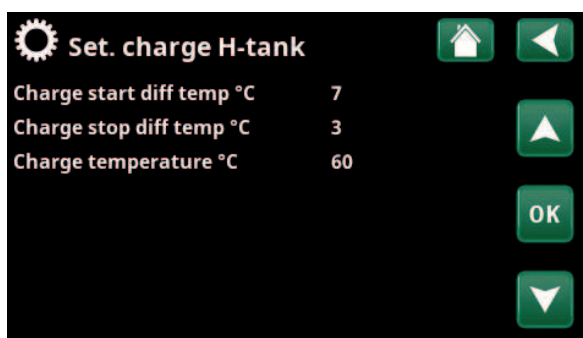

Menu: "Installer/Settings/Solar Panels/Charging to H-tank".

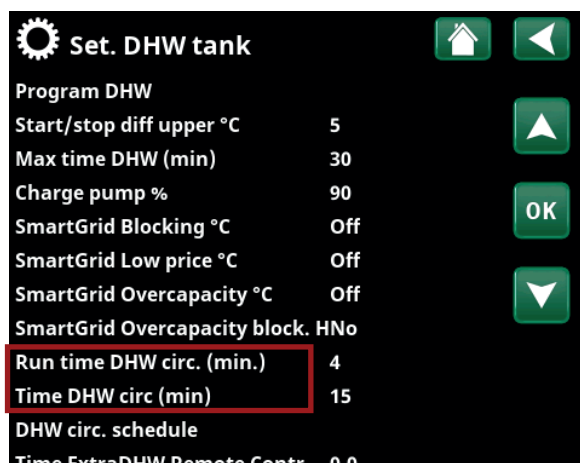

Part of the "Installer/Settings/DHW" menu.

5.4.4 Settings Pool

For more information about setting a weekly program and remotely controlling functions, refer to the main product's "Installation and Maintenance Manual".

Pool **Blocked (On/Blocked)**

Select whether the pool heating should be "On" or "Blocked".

Pool temp °C **22 (20...58)**

Set the desired pool temperature.

Pool diff °C **1.0 (0.2...5.0)**

Specify the permitted difference between the stop and start temperature in the pool.

Pool priority* **Low (Low/High)**

Specify whether additional heat is permitted during pool charging (High).

Max time pool (min)* **20 (1...150)**

Specify the maximum time in minutes for pool heating before charging switches to another destination.

Charge pump %* **50 (20...100)**

Set the charge pump speed (%) for pool charging.

SmartGrid Blocking °C **Off (Off/-1...-50)**

The setpoint for pool heating is decreased by the value set in this menu when "SmartGrid Blocking" is active

SmartGrid Low Price °C **1 (Off, 1...50)**

Set the setpoint increase for pool heating when "SmartGrid Low Price" is active.

SmartGrid Overcapacity °C **2 (Off, 1...50)**

Set the setpoint increase for pool heating when "SmartGrid Overcapacity" is active.

Min rps* **50 (50 ...100)**

The lowest permitted compressor speed during pool heating. When the heat pump switches from the existing destination to Pool, this "rps" is used for pool heating. When the need for energy is low, e.g. during the summer, the power for pool heating can be increased here.

Max rps* **50 (50...100)**

The highest permitted compressor speed during pool heating. Adjustable value varies depending on the model of heat pump/indoor module.

Temp Min rps °C* **22 (5...58)**

Set the pool temperature that applies when the compressor runs on "Min rps".

Temp Max rps °C* **22 (5...58)**

Set the pool temperature that applies when the compressor runs on "Max rps".

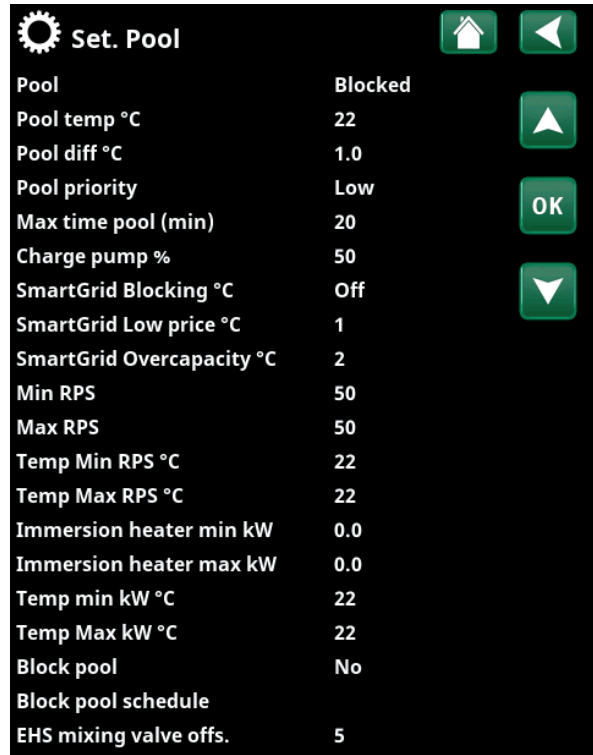

Menu: "Installer/Settings/Pool".

i For more information about setting a weekly program and remotely controlling functions, refer to the main product's "Installation and Maintenance Manual".

*Whether the menu row is displayed depends on the model of heat pump/indoor module.

Electric heater Min. kW* **0.0**

Set electric heater power that applies to "Min. kW" (P1).

Adjustable value varies depending on the model of heat pump/indoor module.

Electric heater Max. kW* **0.0**

Set electric heater power that applies to "Max. kW" (P2).

Adjustable value varies depending on the model of heat pump/indoor module.

Temp. Min. kW °C* **22 (5...58)**

Set pool temperature (T1) that applies to "Min. kW" (P1).

Temp. Max. kW °C* **22 (5...58)**

Set pool temperature (T1) that applies to "Max. kW" (P2).

Block pool **No (No/Yes)**

This function is used to block external pool heating.

Block pool schedule

This menu is used to schedule the weekday periods during which pool heating should be blocked. This schedule is repeated every week.

This menu bar is displayed if a weekly program has been defined for the "Block Pool" function.

EHS mixing valve offs.

Set the temperature difference at which charging from the heat source (EHS tank) should start. The heat source must be this many degree warmer than the tank temperature for charging to start.

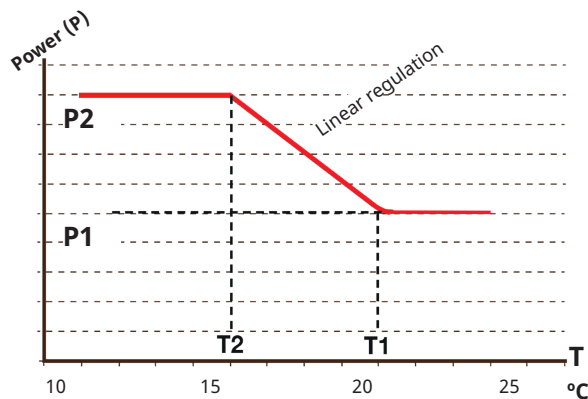

The diagram shows that the electric heater power is regulated depending on the pool temperature.

When the pool temperature is below T2, the electric heater power is regulated up to P2.

When the pool temperature exceeds T1, the electric heater power is regulated down to P1.

These temperature and power limits are set in the menus on the left.

*Whether the menu row is displayed depends on the model of heat pump/indoor module.



5.5 Operation data

Operation data menus for the functions added with the Extension Card EnergyFlex are described below. The operating values specified in the menu screenshots are only examples.

i The pumps and tanks shown in the menu vary depending on the model of heat pump/indoor module.

5.5.1 Solar Panels

To view current operation data, click the "Solar Panels" symbol in the scrollable list at the bottom of the "Operation Data" menu page.

The pumps and tanks shown in the menu vary depending on the model of heat pump/indoor module.

Status

Shows the operating status of the solar control, see explanation in table below.

Solar panel In/Out °C 65/70

Shows the solar panel's incoming and outgoing temperatures.

H-tank (B6) °C / EHS-tank (B47) °C 58

Shows the current temperature in H-tank or EHS-tank depending on the selected solar system.

EcoTank (B41) (B42) °C 72/48

Shows EcoTank's top temperature (sensor B41), the setpoint, and the tank's bottom temperature (sensor B42).

X-volume (B41) (B42) °C 72/48

Shows the X-volume tank's top temperature (sensor B41), the setpoint, and the tank's bottom temperature (sensor B42).

Solar Panel Pump % 78

Shows the speed of the solar panel's charge pump.

Pump heat exch. (G32) % 69

If an intermediate heat exchanger is used, the speed of the charge pump between the intermediate heat exchanger and tank are shown here.

Pump (G46) On

Shows whether the charge pump is in operation during EHS-tank transfer.

Pump H-tank (G46) On

Shows whether the charge pump is in operation during main tank transfer.

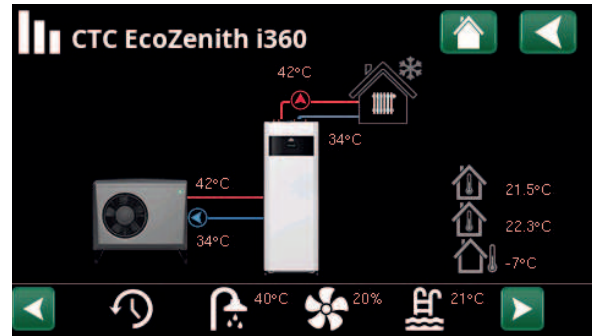

Menu: "Operation Data".

(Example: model CTC EcoZenith i360 with air/water heat pump CTC EcoAir).

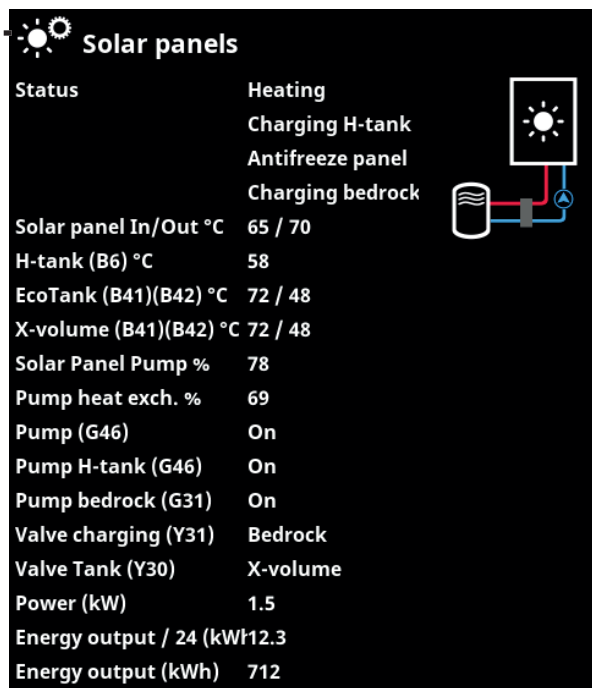

Menu "Operation Data/Solar Panels".



Shortcut to "Settings/Solar Panels".

Pump bedrock (G31) On

Shows whether the charge pump is in operation during bedrock charging.

Valve charging (Y31) Bedrock

Shows whether charging is to tank or borehole.

Valve Tank (Y30) X-volume

When two tanks are being charged by solar power, the position of the 3-way valve between the tanks is shown here.

Power (kW) 1.5

Shows the panel's output.

Energy out/24 h (kWh) 12.3

Shows the amount of energy absorbed in the last 24 hours. If energy is taken from the tanks (e.g. if a panel is being protected against frost), negative energy is calculated. During borehole recharging no useful energy is calculated. The value is updated at the end of the day (00:00).

Energy output (kWh) 712

Shows accumulated amount of energy absorbed in kWh.

Negative values are displayed if energy is taken from the tank, e.g. during sensor test and "Antifreeze panel".

The panel output is displayed during bore hole recharging but the energy is not classed as accumulated.

Status	
Heating/Not heating:	Shows whether the solar collector is heating or not.
Charging H-tank/Charging EcoTank/Charging X-volume/Charging Bedrock	Shows whether H-tank, EcoTank, X-volume and/or bedrock is being charged.
Sensor test selected	Displays "sensor test" when circulation pump is running, to check whether solar panel can heat up.
Charging bedrock	Shows whether circulation pump is stopped to check whether the solar panel can charge the tank
Cooling panel/Cooling tank/Pre-cooling tank/ Frost protect panel	Displayed when any protection function has been activated.

5.5.2 Operation data, Diff thermostat function

This menu is displayed if a wood boiler has been defined in the "Installer/Define/Diff Thermostat Function" menu.

Status On

Shows whether the charge pump is turned on ("On"/"Off").

Temperature °C 51

Temperature in tank **from** which it is charged.

Target temp. °C 43

Temperature in tank that it is charged **to**.

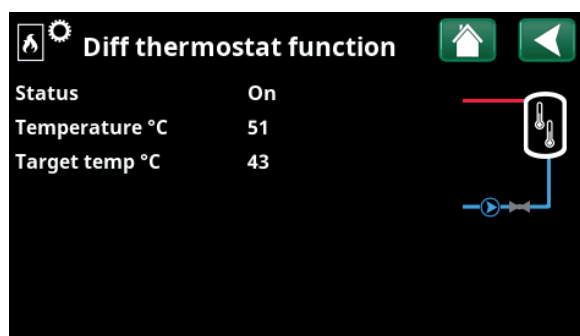

Menu: "Operation Data/Diff. thermostat function".

5.5.3 Operation data, Pool

The heat sources that can charge the pool vary depending on the model of heat pump/control product.

Status **Blocked**

Shows the current operating status ("On", "Off", "Blocked" or "Blocked Externally").

- "Blocked" means that pool heating has been blocked from the "Installer/Settings/Pool" menu.
- "Blocked ext." means that the pool is externally blocked via remote control or a weekly program.

Pool temp °C **24 (24)**

Shows the temperature in the pool and the setpoint that the system is working to achieve.

Demand EHS* **No**

"Yes" means that there is a need for heat in the pool and that heat is taken from the EHS tank.

Demand HP* **No**

"Yes" means that there is a need for heat in the pool and that heat is taken from the heat pump.

Demand ext. boiler* **No**

"Yes" means that there is a need for heat in the pool and that heat is taken from the external boiler.

SmartGrid **Off**

The status of the SmartGrid functions for pool is shown here.

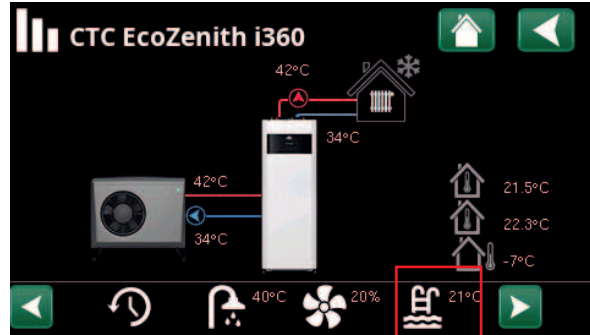

Menu: "Operation data" (example model CTC EcoZenith i360)

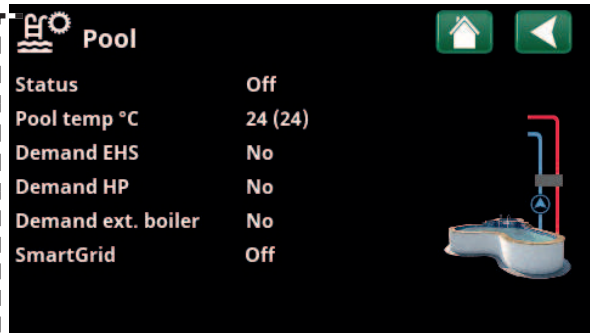

"Operation Data/Pool" menu.

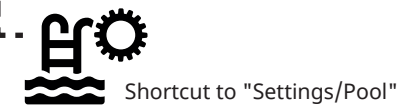

5.5.4 Operation data DHW circulation

Refer to the "Operation Data" chapter in the main product's "Installation and Maintenance Manual" for more information.

DHW circulation **Off**

"On" means the "DHW circulation" function is active.

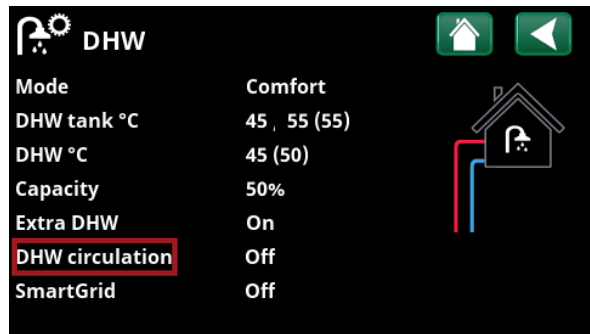

"Operation Data/DHW" menu.

*Whether the menu row is displayed depends on the model of heat pump/indoor module and configuration.



5.6 Service

! This menu is intended for the installer and service engineer only.

i The tanks that can be defined vary depending on the model of heat pump/control product.

5.6.1 Function test

This menu is intended to test the function of the various components in the product. When the menu is activated, all the product's functions stop. Each component can then be tested separately or together. The sensors are checked to ensure that they are connected and displaying a reasonable temperature.

When you exit the menu, the product returns to normal operation. If no button is pressed for 10 minutes, the product automatically returns to normal operation.

5.6.1.1 Test Solar Panels

Pump solar panel (G30) 0...100%
Function test of circulation pump to solar panel.

Heat exchanger pump 0...100%
Function test of circulation pump to intermediate exchanger.

Bedrock (Y31/G31) Tank/Bedrock
Function test of 3-way valve and circulation pump to borehole charging. When "Bedrock" is selected, the flow will go to the bedrock and the circulation pump (G31) will start.

When "Tank" is selected, (G31) should be closed.

Valve 2 tanks (Y30) X-volume/H-tank/EHS-tank
Function test of 3-way valve between the tanks.

The tanks that can be defined vary depending on the model of heat pump/control product.

Pump (G46) Off/On
Function test of circulation pump to tank transfer.

Temperatures

This displays current temperatures.

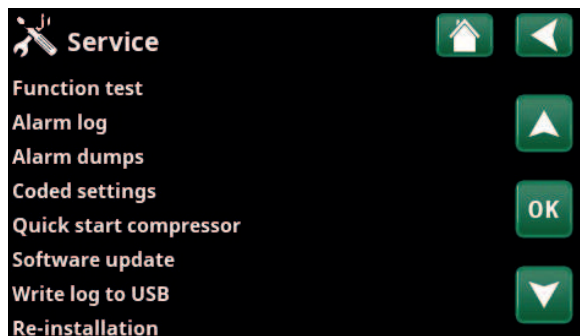

Menu: "Installer/Service" (EZ i360)

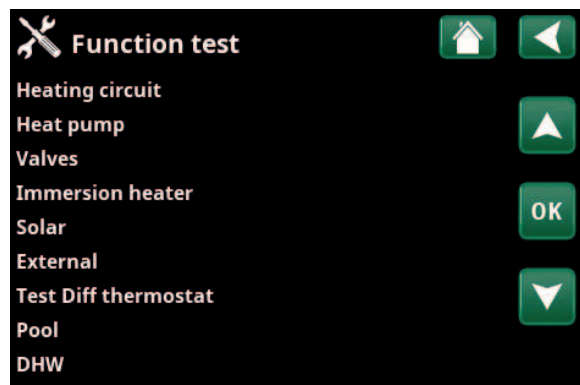

Menu: "Installer/Service/Function Test".

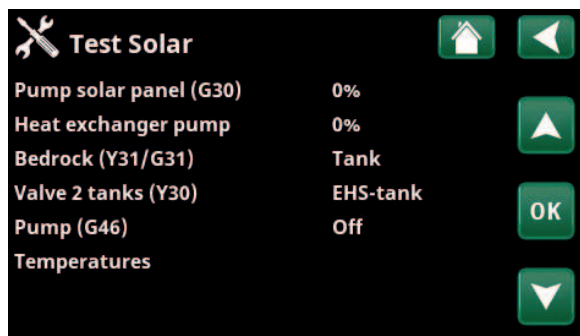

Menu: "Installer/Service/Function Test/Solar Panels"

5.6.1.2 Test Diff thermostat/EHS/External Boiler

The menu rows displayed in the test menu depend on the model of heat pump/indoor module and configuration.

Pump (G46) On/Off

Function test of charge pump for EHS-tank.

Pump H-tank (G46) On/Off

Function test of charge pump for H-tank.

Mixing valve (Y41) Opens/Closes

Function test of mixing valve for EHS-tank.

Mixing valve (Y42) Opens/Closes

Function test of mixing valve for External Boiler.

Ext. Boiler On/Off

Function test of external boiler.

Temperatures

EHS-tank °C (B47)

Shows temperature value on sensor in EHS-tank.

H-tank °C (B6)

Shows temperature value on sensor in H-tank.

Diff thermostat °C (B46)

Shows temperature value on sensor for diff thermostat tank.

Ext. Boiler °C (B9)

Shows temperature value on sensor in external boiler.

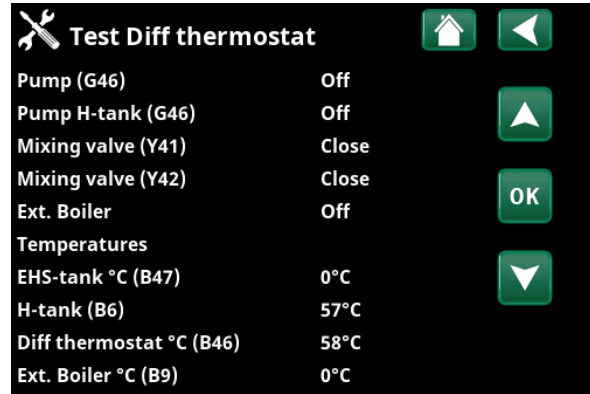

Menu: "Installer/Service/Function Test/Diff Thermostat"

5.6.1.3 Test Pool

Pool pump/Valve (G51/Y50) Off

Function test for pool pump and 3-way valve.

Pool pumps (G50/G51) Off

Function test for pool pumps.

Temperatures

Pool (B50) 21 °C

Shows the pool temperature.

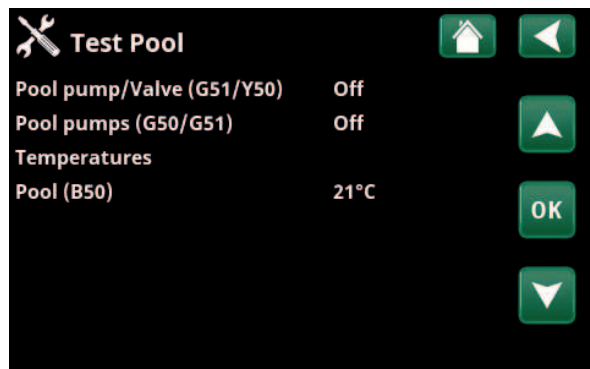

Menu: "Installer/Service/Function Test/Pool".

5.6.1.4 Test DHW circulation pump

Refer to the "Installer/Settings/Function Test" chapter in the main product's "Installation and Maintenance Manual" for more information.

DHW circulation pump (G40) Off/On

Function test of circulation pump for DHW circulation.

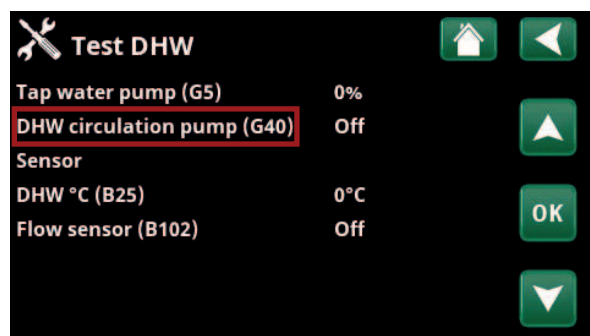

Menu: "Installer/Service/Function Test/DHW".

5.7 Alarm texts and Troubleshooting/Appropriate measures

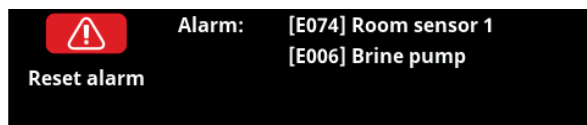

If a fault occurs with e.g. a sensor, an alarm is triggered. A message appears on the display with information about the fault.

You reset the alarm by pressing the Reset Alarm button on the display. If several alarms are triggered, they are displayed one after the other. A persisting fault must first be rectified before it can be reset. Some alarms are reset automatically if the fault ceases.

For solar collectors, it is important for the system to be bled. However, you cannot bleed a hot solar collector. The solar collector system is bled when it is cold, e.g. in the morning.

! NB: If the expansion card has not been installed and solar panels are defined, the product will emit an alarm:
● Comm. error expansion card.

Alarm messages	Description
Sensor	An alarm is displayed if a fault occurs with a sensor that is not connected or has short-circuited and if the value is outside the sensor's range of measurement. The sensor in question is indicated on the display. If a solar sensor or tank sensor is faulty the charging stops. Action: Check the cable connection or sensor; replace the faulty sensor.
[E133] Panel risk of freezing	When the panel temperature is 3°C lower than the frost protection temperature. Action: Check that the protection function "Frost protect panel" is activated (Menu: Panel protection functions).
[E130] Panel/Exchanger-pump	When the panel temperature is 60°C higher than the tank temperature. The circulation pump for the solar panel and/or tank is unable to transfer energy to the tank. Action: Check the function of the pumps.
[E132] Panel pump	The panel temperature is 60°C higher than the tank temperature. The circulation pump for the solar panel is unable to transfer energy to the tank. Action: Check the function of the pump.
[E131] Panel overheated	Panel temperature is above 160°C. Action: Check that the protection functions "Overtemp protect panel" and "Cool overtemp" are activated. (Menu: Panel protection functions).
Comm. error expansion card	When the "Comm. fault expansion card" alarm flashes, this indicates that the communication between the display card and the expansion card is not working. Action: Check the connection between the cards.



CTC AB Box 309 SE-341 26 Ljungby
info@ctc.se +46 372 88 000
www.ctc.se